

Ezi-SERVO®

Closed Loop Stepping System

BT

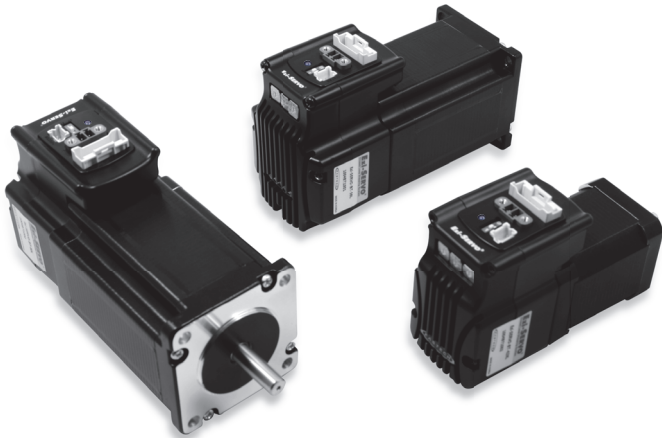

www.fastech.co.kr

Table of Contents

1. Precautions	1
2. Main characteristics	5
3. Drive Specification and Dimension	8
4. Motor Specification and Size	9
4.1 Ezi-SERVO-BT-42 Series	9
4.2 Ezi-SERVO-BT-56 Series	10
4.3 Ezi-SERVO-BT-60 Series	11
4.4 Motor Torque Characteristics	12
5. Installation and Cabling	13
5.1 Notes on Installation	13
5.2 Connection Diagram	13
6. Setting and Operating	14
6.1 Status Monitor LED	14
6.2 In-Position Value Selection Switch(SW1)	15
6.3 Position Controller Gain Selection Switch(SW2)	16
6.4 Resolution Selection Switch(SW3)	16
6.5 In-Position Value Selection Switch(SW4)	17
6.6 Input/Output Connection Connector(CN1)	18
6.7 Power Connection Connector(CN2)	18
6.8 RS-232C Communication Connector(CN3)	19
6.9 Run Current	19
7. System Configuration	20
7.1 Option	20
7.2 Option	21
8. Control Signal Input/Output Description	22
8.1 Input signal	22
8.2 Output signal	23
Appendix	24
Connector	24

※ Before operation ※

- Thank you for your purchasing Ezi-SERVO-BT.
- Ezi-SERVO-BT is an all-in-one Unit. For high-speed and high-precision drive of a stepping motor, Ezi-SERVO-BT is a unique drive that adopts a new control scheme owing to an on-board high-performance 32bit digital signal processor.
- This manual describes handling, maintenance, repair, diagnosis and troubleshooting of Ezi-SERVO-BT.
- Before operating Ezi-SERVO-BT, thoroughly read this manual.
- After reading the manual, keep the manual near the Ezi-SERVO-BT so that any user can read the manual whenever needed.

1. Precautions

◆ General Precautions

- Contents of this manual are subject to change without prior notice for functional improvement, change of specifications or user's better understanding.
Thoroughly read the manual provided with the purchased Ezi-SERVO.
- When the manual is damaged or lost, please contact with Fastech's agents or our company at the address on the last page of the manual.
- Our company is not responsible for a product breakdown due to user's dismantling for the product, and such a breakdown is not guaranteed by the warranty.

◆ Put the Safety First

- Before installation, operation and repairing the Ezi-SERVO, thoroughly read the manual and fully understand the contents. Before operating the Ezi-SERVO please, understand the mechanical characteristics of the Ezi-SERVO and related safety information and precautions.
- This manual divides safety precautions into **Attention** and **Warning**.



Attention :

If user does not properly handle the product, the user may seriously or slightly injured and damages may occur in the machine.



Warning :

If user does not properly handle the product, a dangerous situation (such as an electric shock) may occur resulting in deaths or serious injuries.

- Although precaution is only a **Attention**, a serious result could be caused depending on the situation. Follow safety precautions.

◆ Check the Product



Attention

Check the Product is damaged or parts are missing.
Otherwise, the machine may get damaged or the user may get injured.

◆ Installation



Attention

Carefully move the Ezi-SERVO.
Otherwise the Product may get damaged or User's foot may get injured by dropping the product.

Use non-flammable materials such as metal in the place where the Ezi-SERVO is to be installed.
Otherwise, a fire may occur.

When installing several Ezi-SERVO in a sealed place, install a cooling fan to keep the ambient temperature of the Ezi-SERVO as 50°C or lower.
Otherwise, a fire or other kinds of accidents may occur due to overheating.



Warning

The process of Installation, Connection, Operation, Checking and Repairing should be done with qualified person.
Otherwise, a fire or other kinds of accidents may occur.

◆ Connect Cables



Attention

Keep the rated range of Input Voltage for Ezi-SERVO.
Otherwise, a fire or other kinds of accidents may occur.

Cable connection should follow the wiring diagram.
Otherwise, a fire or other kinds of accidents may occur.



Warning

Before connecting cables, check if input power is off.
Otherwise, an electric shock or a fire may occur.

The case of the Ezi-SERVO is insulated from the ground of the internal circuit by the condenser. Ground the Ezi-SERVO.
Otherwise, an electric shock or a fire may occur.

◆ Operation



Attention

If a protection function(alarm) occurs, firstly remove its cause and then release(alarm reset) the protection function.

If you are operating continuously without removing its cause, the machine may get damaged or the user may get injured.

Do not make Motor Free and make input signal to ON during operation.

Motor will stop and stop current will become zero. The machine may get damaged or the user may get injured.

Make all input signals to OFF before supply input voltage to Ezi-SERVO.

The machine may get damaged or the user may get injured by motor operation.

All parameter values are set by default factory setting value. Change this value after reading this manual thoroughly.

Otherwise, the machine may get damaged or other kinds of accidents may occur.

◆ Check and Repair



Warning

Stop supplying power to the main circuit and wait for a while before checking or repairing the Ezi-SERVO.

Electricity remaining in the capacitor may cause danger.

Do not change cabling while power is being supplied.

Otherwise, the user may get injured or the product may get damaged.

Do not reconstruct the Ezi-SERVO.

Otherwise, an electric shock may occur or the reconstructed product can not get After-Service.

■ Part Numbering

Ezi-SERVO-BT-42S-A-□

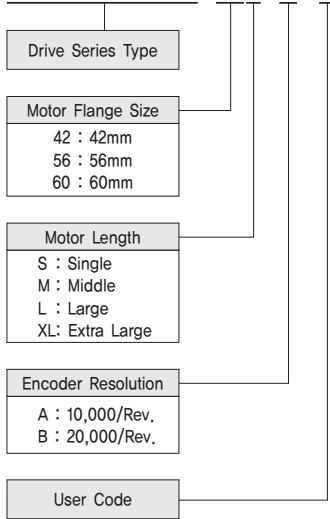

■ Combination List of Ezi-SERVO-BT

Unit Part Number
Ezi-SERVO-BT-42S-A
Ezi-SERVO-BT-42S-B
Ezi-SERVO-BT-42M-A
Ezi-SERVO-BT-42M-B
Ezi-SERVO-BT-42L-A
Ezi-SERVO-BT-42L-B
Ezi-SERVO-BT-42XL-A
Ezi-SERVO-BT-42XL-B
Ezi-SERVO-BT-56S-A
Ezi-SERVO-BT-56S-B
Ezi-SERVO-BT-56M-A
Ezi-SERVO-BT-56M-B
Ezi-SERVO-BT-56L-A
Ezi-SERVO-BT-56L-B
Ezi-SERVO-BT-60S-A
Ezi-SERVO-BT-60S-B
Ezi-SERVO-BT-60M-A
Ezi-SERVO-BT-60M-B
Ezi-SERVO-BT-60L-A
Ezi-SERVO-BT-60L-B

2. Main characteristics

1 Closed Loop System

Ezi-SERVO-BT[®] is an innovative closed loop stepping motor and controller that utilizes a high-resolution motor mounted encoder to constantly monitor the motor shaft position. The encoder feedback feature allows the Ezi-SERVO-BT[®] to update the current motor shaft position information every 25 micro seconds. This allows the Ezi-SERVO-BT[®] drive to compensate for the loss of position, ensuring accurate positioning. For example, due to a sudden load change, a conventional stepper motor and drive could lose a step creating a positioning error and a great deal of cost to the end user!

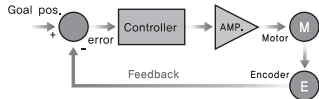

2 No Gain Tuning

Conventional servo systems, to ensure machine performance, smoothness, positional error and low servo noise, require the adjustment of its servo's gains as an initial crucial step. Even systems that employ auto-tuning require manual tweaking after the system is installed, especially if more than one axis are interdependent. Ezi-SERVO-BT[®] employs the best characteristics of stepper and closed loop motion controls and algorithms to eliminate the need of tedious gain tuning required for conventional closed loop servo systems. This means that Ezi-SERVO-BT[®] is optimized for the application and ready to work right out of the box! The Ezi-SERVO-BT[®] system employs the unique characteristics of the closed loop stepping motor control, eliminating these cumbersome steps and giving the engineer a high performance servo system without wasting setup time. Ezi-SERVO-BT[®] is especially well suited for low stiffness loads (for example, a belt and pulley system) that some-time require conventional servo systems to inertia match with the added expense and bulk of a gearbox. Ezi-SERVO-BT[®] also performs exceptionally, even under heavy loads and high speeds!

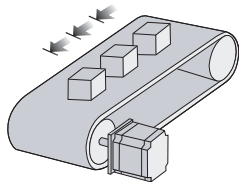

Belt and Pulley System

3 No Hunting

Traditional servo motor drives overshoot their position and try to correct by overshooting the opposite direction, especially in high gain applications. This is called null hunt and is especially prevalent in systems that the break away or static friction is significantly higher than the running friction. The cure is lowering the gain, which affects accuracy or using Ezi-SERVO-BT[®] Motion Control System! Ezi-SERVO-BT[®] utilizes the unique characteristics of stepping motors and locks itself into the desired target position, eliminating Null Hunt. This feature is especially useful in applications such as nanotech manufacturing, semiconductor fabrication, vision systems and ink jet printing in which system oscillation and vibration could be a problem.

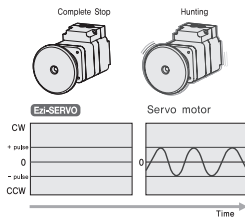

4 Smooth and Accurate

Ezi-SERVO-BT[®] is a high-precision servo drive, using a high-resolution encoder with 32,000 pulses/revolution. Unlike a conventional Microstep drive, the on-board high performance DSP(Digital Signal Processor) performs vector control and filtering, producing a smooth rotational control with minimum ripples.

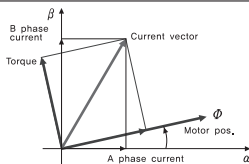

5 Fast Response

Similar to conventional stepping motors, Ezi-SERVO-BT[®] instantly synchronizes with command pulses providing fast positional response. Ezi-SERVO-BT[®] is the optimum choice when zero-speed stability and rapid motions within a short distance are required. Traditional servo motor systems have a natural delay between the commanding input signals and the resultant motion because of the constant monitoring of the current position, necessitating in a waiting time until it settles, called settling time.

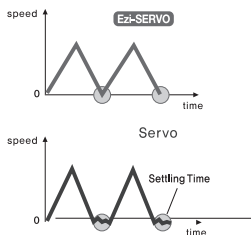

6 High Resolution

The unit of the position command can be divided precisely.
(Max, 32,000 pulses/revolution)

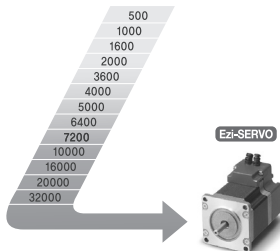

7 High Torque

Compared with common step motors and drives, Ezi-SERVO-BT[®] motion control systems can maintain a high torque state over relatively long period of time. This means that Ezi-SERVO-BT[®] continuously operates without loss of position under 100% of the load. Unlike conventional microstep drives, Ezi-SERVO-BT[®] exploits continuous high-torque operation during high-speed motion due to its innovative optimum current phase control.

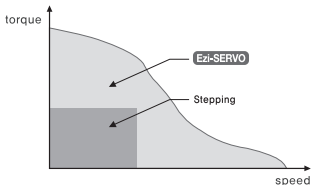

8 High Speed

The Ezi-SERVO-BT[®] functions well at high speed without the loss of Synchronism or positioning error. Ezi-SERVO's ability of continuous monitoring of current position enables the stepping motor to generate high-torque, even under a 100% load condition.

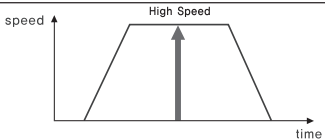

3. Drive Specification and Dimension

3.1 Drive Specification

	Input Voltage	24VDC \pm 10%
	Control Method	Closed loop control with 32bit DSP
	Current Consumption	Max : 500mA (Except motor current)
Operating Condition	Ambient Temperature	In Use : 0~50°C In Storage : -20~70°C
	Humidity	In Use : 35~85%RH (Non-Condensing) In Storage : 10~90%RH (Non-Condensing)
	Vib. Resist.	0.5G
Function	Rotation Speed	0~3,000rpm
	Resolution(P/R)	10,000/Rev. Encoder model : 500 1,000 1,600 2,000 3,600 5,000 6,400 7,200 10,000 20,000/Rev. Encoder model : 500 1,000 1,600 2,000 3,600 5,000 6,400 7,200 10,000 20,000 (Selectable with Rotary switch)
	Max. Input Pulse Frequency	500KHz (Duty 50%)
	Protection Functions	Over current, Over speed, Position tracking error, Over load, Over temperature, Over regenerated voltage, Motor connect error, Encoder connect error, Motor voltage error, Inposition error, System error, ROM error, Input voltage error, Position overflow error
	In-Position Selection	0~F (Selectable with Rotary switch)
	Position Gain Selection	0~F (Selectable with Rotary switch)
	Pulse Input Method	1-Pulse/2-Pulse (Selectable with DIP switch)
	Speed/Position Control Command	Pulse train input
I/O Signal	Input Signal	Position command pulse, Servo On/Off, Alarm reset (Photocoupler input)
	Output Signal	In-Position, Alarm (Photocoupler output) Encoder signal (A+, A-, B+, B-, Z+, Z-, 26C31 of Equivalent), (Line Driver output)

4. Motor specifications and Size

4.1 Ezi-SERVO-BT-42 Series

4.1.1 Motor Specifications

M O D E L		UNIT	Ezi-SERVO -BT 42S Series	Ezi-SERVO -BT 42M Series	Ezi-SERVO -BT 42L Series	Ezi-SERVO -BT 42XL Series
DRIVE METHOD		----	BI-POLAR	BI-POLAR	BI-POLAR	BI-POLAR
NUMBER OF PHASES		----	2	2	2	2
VOLTAGE		VDC	3,36	4,32	4,56	7,2
CURRENT per PHASE		A	1,2	1,2	1,2	1,2
RESISTANCE per PHASE		Ohm	2,8	3,6	3,8	6
INDUCTANCE per PHASE		mH	2,5	7,2	8	15,6
HOLDING TORQUE		N · m	0,32	0,44	0,5	0,8
ROTOR INERTIA		g · cm ²	35	54	77	114
WEIGHTS		g	220	280	350	500
LENGTH (L)		mm	33	39	47	59
ALLOWABLE OVERHUNG LOAD (DISTANCE FROM END OF SHAFT)	3mm	N	22	22	22	22
	8mm		26	26	26	26
	13mm		33	33	33	33
	18mm		46	46	46	46
ALLOWABLE THRUST LOAD		N	Lower than motor weight			
INSULATION RESISTANCE		MOhm	100min. (at 500VDC)			
INSULATION CLASS		----	CLASS B (130°C)			
OPERATING TEMPERATURE		°C	0 to 55			

4.1.2 Motor Dimension (mm)

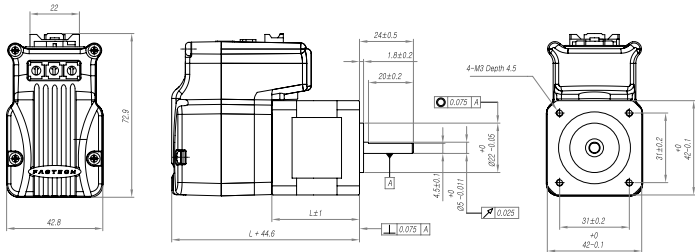

4.2 Ezi-SERVO-BT-56 Series

4.2.1 Motor Specifications

M O D E L		UNIT	Ezi-SERVO-BT 56S Series	Ezi-SERVO-BT 56M Series	Ezi-SERVO-BT 56L Series
DRIVE METHOD		----	BI-POLAR	BI-POLAR	BI-POLAR
NUMBER OF PHASES		----	2	2	2
VOLTAGE		VDC	1,56	1,62	2,7
CURRENT per PHASE		A	3	3	3
RESISTANCE per PHASE		Ohm	0,52	0,54	0,9
INDUCTANCE per PHASE		mH	1	2	3,8
HOLDING TORQUE		N · m	0,64	1	2
ROTOR INERTIA		g · cm ²	120	200	480
WEIGHTS		g	500	700	1150
LENGTH (L)		mm	46	54	80
ALLOWABLE OVERHUNG LOAD (DISTANCE FROM END OF SHAFT)	3mm	N	52	52	52
	8mm		65	65	65
	13mm		85	85	85
	18mm		123	123	123
ALLOWABLE THRUST LOAD		N	Lower than motor weight		
INSULATION RESISTANCE		MOhm	100min. (at 500VDC)		
INSULATION CLASS		----	CLASS B (130°C)		
OPERATING TEMPERATURE		°C	0 to 55		

4.2.2 Motor Dimension (mm)

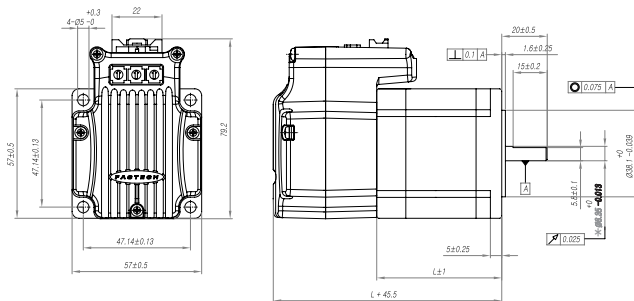

* : There are 2 kinds size of front shaft diameter for EzM-56 series as $\Phi 6,35$ and $\Phi 8,0$.

4.3 Ezi-SERVO-BT-60 Series

4.3.1 Motor Specifications

MODEL		UNIT	Ezi-SERVO-BT 60S Series	Ezi-SERVO-BT 60M Series	Ezi-SERVO-BT 60L Series
DRIVE METHOD		----	BI-POLAR	BI-POLAR	BI-POLAR
NUMBER OF PHASES		----	2	2	2
VOLTAGE		VDC	2,4	3,6	4,38
CURRENT per PHASE		A	6	6	6
RESISTANCE per PHASE		Ohm	0,4	0,6	0,73
INDUCTANCE per PHASE		mH	3,5	6,5	8,68
HOLDING TORQUE		N · m	4,5	8,5	12
ROTOR INERTIA		g · cm ²	1400	2700	4000
WEIGHTS		Kg	2,4	3,9	5,4
LENGTH (L)		mm	79	117	155
ALLOWABLE OVERHUNG LOAD (DISTANCE FROM END OF SHAFT)	3mm	N	270	270	270
	8mm		300	300	300
	13mm		350	350	350
	18mm		400	400	400
ALLOWABLE THRUST LOAD		N	Lower than motor weight		
INSULATION RESISTANCE		MOhm	100min. (at 500VDC)		
INSULATION CLASS		----	CLASS B (130°C)		
OPERATING TEMPERATURE		°C	0 to 55		

4.3.2 Motor Dimension (mm)

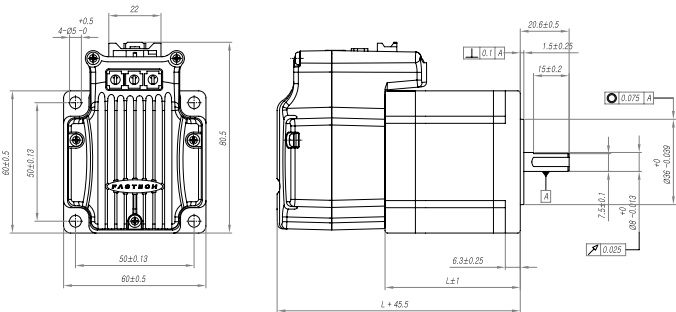

4.4 Motor Torque Characteristics

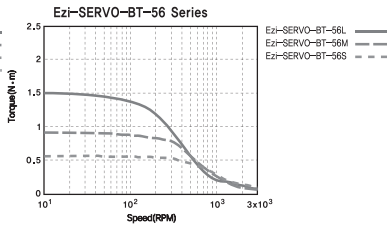
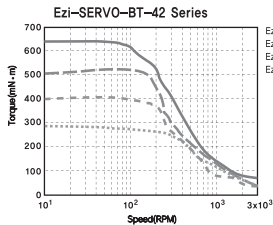

※Measured Condition

Motor Voltage = 24VDC
 Motor Current = Rated Current(Refer to Motor Specification)
 Drive = Ezi-SERVO-BT

※Measured Condition

Motor Voltage = 24VDC
 Motor Current = Rated Current(Refer to Motor Specification)
 Drive = Ezi-SERVO-BT

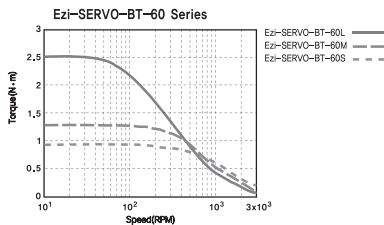

※Measured Condition

Motor Voltage = 24VDC
 Motor Current = Rated Current(Refer to Motor Specification)
 Drive = Ezi-SERVO-BT

5. Installation and Cabling

5.1 Notes on Installation

- 1) Ezi-SERVO-BT is designed for indoor use only.
- 2) The ambient temperature of the room should be 0°C~50°C.
- 3) If the temperature of the product case is higher than 50°C, radiate heat of the outside to cool down.
- 4) Do not install Ezi-SERVO-BT under direct rays, near magnetic or radioactive objects.

5.2 Connection Diagram

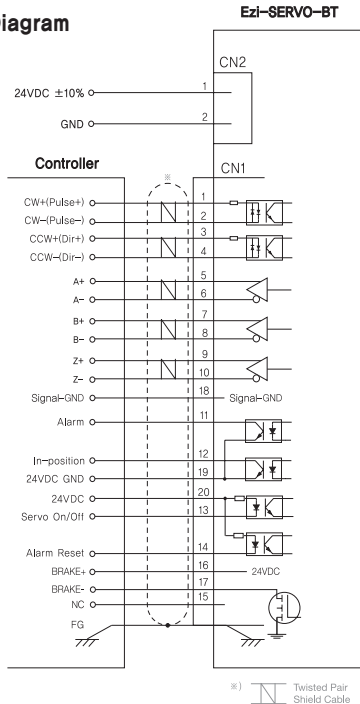

6. Setting and Operation

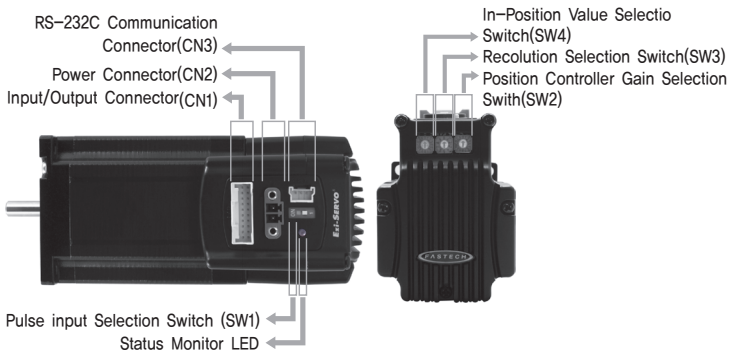

6.1 Status Monitor LED

6.1.1 Status LED Function and Condition

Color	Function	Flash Condition
Green	Power input	Lights when power is On
Red	Alarm indication	Flash when protection function is activated (Identifiable which protection mode is activated by counting the LED flash times)

6.1.2 Protection functions and LED flash times

Times	Protection	Conditions
1	Over current	The current through power devices in inverter exceeds the limit value
2	Over speed	Motor speed exceed 3,000rpm
3	Position tracking error	Position error value is higher than 90° in motor run state
4	Over load	The motor is continuously operated more than 5 second under a load exceeding the max. torque
5	Over temperature	Inside temperature of drive exceeds 55°C
6	Over regenerated voltage	Back-EMF is more high limit value
7	Motor connect error	The power is ON without connection of the motor cable to drive
8	Encoder connect error	Cable connection error with Encoder connector in drive
9	Motor voltage error	Motor voltage is less than low limit value
10	Inposition error	After operation is finished, a position error occurs
11	System error	Error occurs in drive system
12	ROM error	Error occurs in parameter storage device(ROM)
15	Position overflow error	Position error value is higher than 90° in motor stop state



Alarm LED flash
(ex : Position tracking error)

6.2 Pulse Input Selection Switch(SW1)

Indication	Switch Name	Functions	ON
2P/1P	Selecting pulse input mode	Selectable 1-Pulse input mode or 2-Pulse input mode as Pulse input signal, ON : 1-Pulse mode OFF : 2-Pulse mode ※Default : 2-Pulse mode	<input checked="" type="checkbox"/> <input type="checkbox"/> 1

6.3 Position Controller Gain Selection Switch(SW2)

The purpose of the Position Controller is to correct motor position deviation after stopping caused by load and friction, Depending on the motor load, the user have to select position of the switch because the system to be stable and to correct the error as fast as possible,

-To turn the controller

1. Set the switch to '0' position
2. Start to rotate the switch until system becomes stable.
3. Rotate the switch +/- 1~2 position to reach better performance.

Indication	Time constant of integral part	Proportion-al Gain*1	Indication	Time constant of integral part	Proportion-al Gain*1
0	1	1	8	2	3
1	1	2	9	2	4
2	1	3	A	2	5
3*2	1	4	B	3	1
4	1	5	C	3	2
5	1	6	D	3	3
6	2	1	E	3	4
7	2	2	F	3	5



*1 : Values in the columns are in relative units,

They only show the parameter changes depending on the switch's position,

*2 : Default : '3'

6.4 Resolution Selection Switch(SW3)

The number of pulse per revolution,

Position	Pulse/Rotation	Position	Pulse/Rotation
0	500*1	5	3,600
1	500	6	5,000
2	1,000	7	6,400
3	1,600	8	7,200
4	2,000	9	10,000*2



*1 : Resolution value depend on encoder type,

*2 : Default : 10,000

6.5 In-Position Value Selection Switch(SW4)

To select the output condition of In-position signal, In-position output signal is generated when the pulse number of position error is lower than selected In-position value set by this switch after positioning command executed.

Indication	In-Position [Pulse] Fast Response	Indication	In-Position [Pulse] Fast Response
0*1	0	8	0
1	1	9	1
2	2	A	2
3	3	B	3
4	4	C	4
5	5	D	5
6	6	E	6
7	7	F	7



*1 : Default : '0'

6.5.1 Setting method of Fast Response and Accurate Response

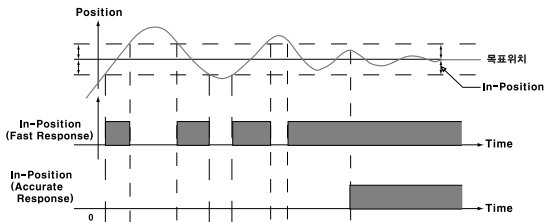

6.6 Input/Output Connection Connector(CN1)

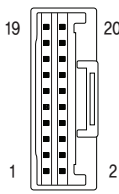
Pin No.	Function	I/O Signal	Pin Layout
1	CW+(Pulse+)	Input	 <p>※BRAKE function is Optional.</p>
2	CW-(Pulse-)	Input	
3	CCW+(Dir+)	Input	
4	CCW-(Dir-)	Input	
5	A+	Output	
6	A-	Output	
7	B+	Output	
8	B-	Output	
9	Z+	Output	
10	Z-	Output	
11	Alarm	Output	
12	In-Position	Output	
13	Servo On/Off	Input	
14	Alarm Reset	Input	
15	NC	----	
16	BRAKE+	Output	
17	BRAKE-	Output	
18	S-GND	Output	
19	24VDC GND	Input	
20	24VDC	Input	

6.7 Power Connection Connector(CN2)

Pin No.	Function	Pin Layout
1	Input Power : 24VDC \pm 10%	
2	Input Power : GND	

6.8 RS-232C Communication Connector (CN3)

Pin No.	Function	Pin Layout
1	Rx	
2	Tx	
3	GND	

Used to set paramete on the computer. Communication speed 115,200bps.
For setting parameter Use GUI in package.

6.9 Run Current

There's no need to adjust because the run current is set with comparing to the kind of motor.
But, the run current is 50% when motor is stopped.

7. System Configuration

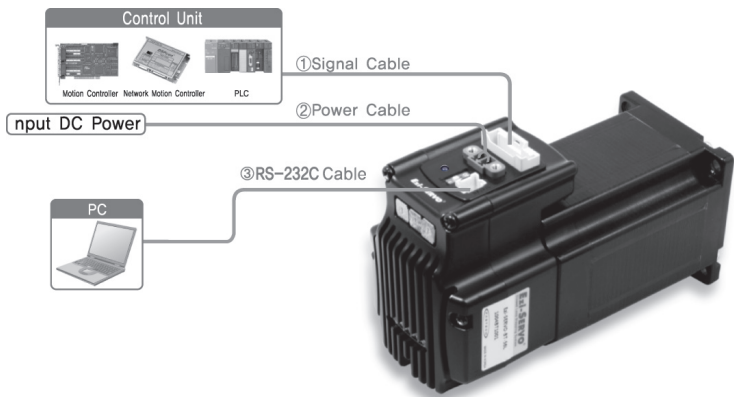

Type	Power Cable	Signal Cable
Standard Length	—	—
Max. Length	2m	20m

7.1 Option

①Signal Cable

Available to connect between Control Unit and Ezi-SERVO-BT.

Item	Length[m]	Remark
CSVB-S-□□□F	□□□	Normal Cable
CSVB-S-□□□M	□□□	Robot Cable

□ is for Cable Length. The unit is 1m and Max. 20m length..

②Power Cable

Available to connect between Power and Ezi-SERVO-BT.

Item	Length[m]	Remark
CSVA-P-□□□F	□□□	Normal Cable
CSVA-P-□□□M	□□□	Robot Cable

□ is for Cable Length. The unit is 1m and Max. 2m length.

7.2 Option

③Communication Connector Cable (USB Cable)

Item	Length[m]	Remark
CGNR-U-002F	2	Normal Cable
CGNR-U-003F	3	
CGNR-U-005F	5	

8. Control signal Input/Output Description

8.1 Input Signal

Input signals of the drive are all photocoupler inputs. The signal shows the status of internal photocouplers [ON:conduction], [OFF:Non-conduction], not displaying the voltage levels of the signal.

CW(Pin:1,2), CCW(Pin:3,4)

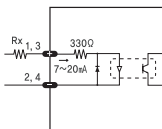

Alarm Reset(Pin:14)
Servo On/Off(Pin:13)

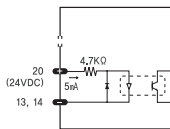

◆ CW, CCW Input

This signal can be used to receive a positioning pulse command from a user host motion controller. A user can select 1-pulse input mode or 2-pulse input mode (refer to switch No.1, SW1). The input schematic of CW, CCW is designed for 5V TTL level. When using 5V level as an input signal, the resistor Rx is not used and connect to the driver directly. When the level of input signal is more than 5V, Rx Resistor is required. If the resistor is absent, the drive will be damaged! In input signal level is 12V case, Rx value is 2,2kohm and in 24V case, 4,7kohm is suitable for Rx value.

◆ Servo On/Off Input

This input can be used only to adjust the position by manually moving the motor shaft from the load-side. By setting the signal [ON], the driver cuts off the power supply to the motor. Then, one can manually adjust output position. When setting the signal back to [OFF], the driver resumes the power supply to the motor and recovers the holding torque. When driving a motor, one needs to set the signal [OFF].

◆ Alarm Reset Input

When a protection mode has been activated, a signal to this alarm reset input cancels the Alarm output,

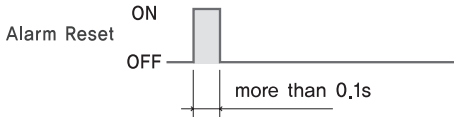

※By setting the alarm reset input signal [ON], cancel the Alarm output,
Before cancel the Alarm output, have to remove the source of Alarm,

8.2 Output Signal

Output signals from the driver are photocoupler outputs : Alarm, In-Position and the line driver outputs(encoder signal). In the case of photocoupler outputs, the signal indicates the status of internal photocouplers [ON:conduction], [OFF:Non-conduction], not displaying the voltage levels of the signal.

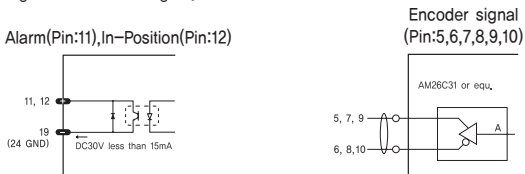

◆ Alarm Output

The Alarm output indicates [ON] when the driver is in a normal operation. If a protection mode has been activated, it goes [OFF]. A host controller needs to detect this signal and stop sending a motor driving command. When the driver detects an abnormal operation such as overload or overcurrent of the motor, it sets the Alarm output to [OFF], blinks the Alarm LED, disconnect the power to a motor and stop the motor simultaneously.

[Caution] Only at the Alarm output port, the photocoupler operation is in reverse. When the driver is in normal operation the Alarm output is [ON]. On the contrary when the driver is in abnormal operation that start protection mode, the Alarm output is [OFF].

◆ In-Position Output

In-Position signal is [ON] when positioning is completed. This signal is [ON] when the motor position error is within the value set by the switch SW4.

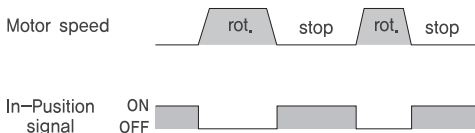

[Caution] In-Position signal is [ON] when low speed(under 50[pps]) Motioning even if The position command is not finished.

◆ Encoder Signal Output

The encoder signal is a line drive output. This can be used to confirm the stop position.

Appendix

▪ Connector

Connector specifications for cabling to Ezi-SERVO-BT.

ITEM		Part Number	Maker
Power (CN2)	Terminal Block	AKZ1550/2F-3,81	PTR
Signal (CN1)	Housing	501646-2000	MOLEX
	Terminal	501648-1000(AWG 26~28)	MOLEX
RS-232C communication (CN3)	Housing	33507-0300	MOLEX
	Terminal	50212-8100	MOLEX

These connectors are serviced together with Ezi-SERVO-BT except when purchasing option cables.

Above connector is the most suitable product for Ezi-SERVO-BT. Another equivalent connector can be used.

Advantages over Open-loop Control Stepping Drive

1. Reliable positioning without loss of synchronism.
2. Holding stable position and automatically recovering to the original position even after experiencing positioning error due to a external force, such as mechanical vibration or vertical positioning holding.
3. Ezi-SERVO utilizes 100% full range of the rated motor torque, contrary to a conventional open-loop stepping drive that can use only up to 50% of the rated motor torque by considering loss of synchronism.
4. Capability to operate at high speed due to load-dependent current control, open-loop stepper drives use a constant current control at all speed range without considering load variations.

Advantages over servo motor controller

1. No gain tuning (Automatic adjustment of gain in response to a load change)
2. Maintain the stable holding position without fluctuation after completing positioning.
3. Fast positioning due to the independent control by on-board DSP.
4. Continuous operation during rapid short-stroke movement due to instantaneous positioning.



FASTECH Co., Ltd.

Rm #1202, Bucheon Technopark 401 Dong, Yakdeae-dong,
Wonmi-Gu, Bucheon-si, Gyeonggi-do, Rep. Of Korea (Zip)420-734
TEL : 82-32-234-6300,6301 FAX : 82-32-234-6302
E-mail : daniel@fastech.co.kr website: www.fastech.co.kr

- Please note that the specifications are subject to change without notice due to product improvements.

© Copyright 2007 FASTECH Co., Ltd, Aug 21, 2012 Rev.12