

**DYNAMIK DURCH
WIDERSTAND**

***DYNAMICS
THROUGH RESISTANCE***

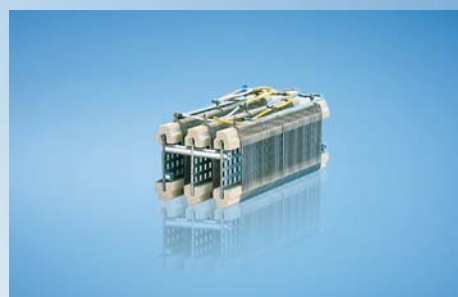

FRIZLEN
LEISTUNGSWIDERSTÄNDE
POWER RESISTORS

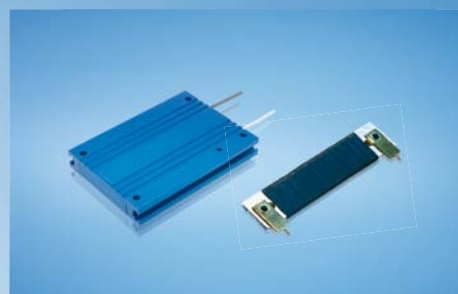

DYNAMIK DURCH WIDERSTAND

Wir über uns

DYNAMICS THROUGH RESISTANCE

About us

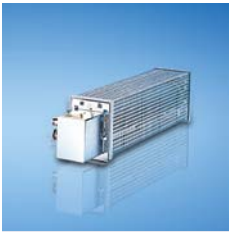

DIE KLASSIKER

Drahtgewickelte Rohrfestwiderstände
10 bis 6000 Watt

THE ORIGINAL ONES

Wirewound tubular fixed resistors
10 up to 6000 Watt



DIE FLEXIBLEN

**Zementierte
Drahtdrehwiderstände**
16 bis 1500 Watt

THE FLEXIBLE ONES

**Cement coated wirewound
variable resistors**
16 up to 1500 Watt

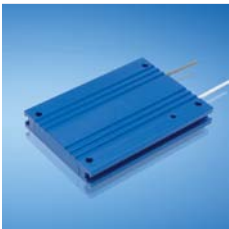

DIE INNOVATIVEN

**Drahtgewickelte Flachwiderstände,
auch gekapselt und in wassergekühlter
Ausführung**
5 bis 40000 Watt

THE INNOVATIVE ONES

**Wirewound flat resistors,
also enclosed and
watercooled**
5 up to 40000 Watt



DIE BELASTBAREN

Last- und Prüfwiderstände
0,01 bis 250 Kilowatt

THE LOADABLE ONES

Load- and test resistors
0.01 up to 250 Kilowatt



DIE MODULAREN

**Drahtgewickelte
Lamellenfestwiderstände**
0,15 bis 30 Kilowatt

THE MODULAR ONES

**Wirewound lamina type
fixed resistors**
0,15 up to 30 Kilowatt



DIE ROBUSTEN

Stahlgitterfestwiderstände
0,5 bis 250 Kilowatt

THE ROBUST ONES

Steel-grid fixed resistors
0,5 up to 250 Kilowatt



FRIZLEN SONDERGERÄTE

DC-POWERSWITCH
Kundenspezifische Widerstandsgeräte

FRIZLEN SPECIAL DEVICES

DC-POWERSWITCH
Customised resistor units

Das richtige Produkt für Ihre Anwendung

Suitable products for your application

Anwendungen	Application	Typleistung [kW]		Produktgruppe					
		min.	max.	T 100	T 200	T 300	T 400	T 500	T 600
Bremswiderstände für Frequenzumrichter- und Gleichstromantriebe	<i>Braking resistors for frequency converters and DC drives</i>	0,01	40,0			X		X	
		0,01	6,0	X				X	X
		6,0	30,0					X	X
		30,0	250						X
Belastungswiderstände für Spannungsquellen, Batterien, USV-Geräte, Generatoren und Netzgeräte	<i>Load resistors for supply units, power packs, batteries, UPS units and generators</i>	0,01	250				X		
Stufenlose Drehzahlverstellung von kleinen Gleich- und Wechselstrommotoren	<i>Stepless variable speed adjustment for small AC and DC motors</i>	0,01	1,5		X		X		
Feldsteller für Generatoren, Widerstände zur Strom- und Spannungsbegrenzung	<i>Field rheostats for generators, resistors for current and voltage limitation</i>	0,01	3,8	X	X				
Motorische Potentiometer als fernbetätigte Sollwertgeber	<i>Motorised potentiometers as nominal value setters</i>	0,01	1,5		X				
Widerstandsbaugruppen für Einbau in leistungselektronische Geräte	<i>Resistor modules fitting into electronic power devices</i>	0,01	0,75	X		X		X	
		0,3	2,0					X	
Anlass- und Stellwiderstände für Schleifringläufer- und Gleichstrommotoren	<i>Starting and regulating resistors for slip-ring rotor and DC motors</i>	0,15	30,0					X	
		0,5	250						X
Ständer-Vorschaltwiderstände für Kurzschlussläufermotoren	<i>Stator series resistors for squirrel-cage motors</i>	0,5	250						X
Strombegrenzungswiderstände zur Ladung und Entladung von Kondensatoren	<i>Resistors for current limitation e.g. for charging and discharging of capacitors</i>	0,01	1,0	X		X		X	
Experimentier- und Prüfwiderstände in Laboratorien, Schulen und Universitäten	<i>Resistors for experimenting and testing in laboratories, schools and universities</i>	0,01	50				X		
Widerstände zur Schutzbeschaltung, Filterwiderstände	<i>Protective resistors, filter resistors</i>	0,01	0,75	X		X		X	
		0,75	6,0	X				X	
		1,5	22,0						X



Wir über uns

Mit FRIZLEN Leistungswiderständen haben Sie elektrische Leistung voll im Griff.



Unser umfassendes Know-how zeigt sich im kompletten Spektrum vom Einzelstück bis zur Serie, für Leistungen von 5 Watt bis 250 Kilowatt.



Einsatz- und Anwendungsgebiete stellen die Anforderungen, die Lösungen entwickeln wir.

Ihrem Anforderungsprofil entsprechend berechnen und fertigen wir Widerstände und Widerstandskombinationen unter Berücksichtigung Ihrer Vorgaben. Natürlich beraten wir Sie gern und ermitteln auf Wunsch die Widerstandsdimensionierung mit Hilfe EDV-gestützter Berechnung und Simulation.

Hochwertige Standard- sowie Sonderlösungen von FRIZLEN sorgen für Dynamik im Verbund mit leistungselektronischen Geräten in Maschinen und Anlagen. Bewegung zu stoppen, konstant zu halten und exakte Abläufe zu ermöglichen – dabei unterstützen wir die elektrische Antriebstechnik und verbessern so die Dynamik Ihrer Antriebe.

About us

Keep your electric power under control with FRIZLEN power resistors.

Our extensive know-how is demonstrated in a complete spectrum from single item up to series production, for power values from 5 watts up to 250 kilowatts.

Different ranges of use and application set the requirements, we provide the solutions.

We design and produce resistors and resistor combinations exactly to meet your requirements. We are, of course, happy to advise you according to your specification. Upon request, we can determine resistor dimensioning using our computer-supported calculation and simulation system.

High-quality standard and special solutions from FRIZLEN ensure dynamics when you are dealing with high performance electrical equipment in machines and processes. We support electrically driven power engineering by stopping movement, keeping it constant and ensuring exact sequences, which improves the dynamics of your drive systems.

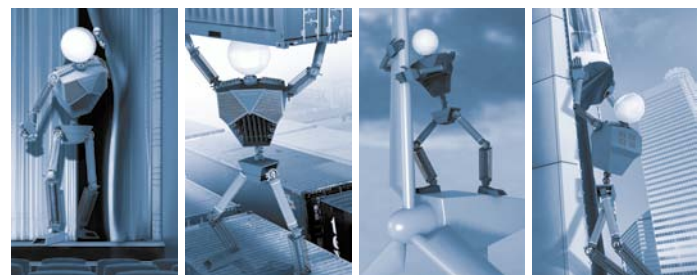



Drahtgewickelte Lamellenfestwiderstände

0,15 bis 30 Kilowatt

Drahtgewickelte Lamellenfestwiderstände als Einzelelemente, die einbaufähig sind und daraus aufgebaute Lamellenfestwiderstandsgeräte in verschiedenen Schutz- und Befestigungsarten.

- Anschluss an Litzen, Schraubschellen oder Klemmen, Abgreifschellen möglich
- Einzellamellen zu Baugruppen kombiniert für spezielle Einbaulösungen in Schutzart IP00
- Für Wand- oder Bodenmontage in Schutzart IP20 oder IP23
- Thermisches Überstromrelais, Temperaturschalter oder FRIZLEN DC-Powerswitch für thermische Überwachung und Abschaltung

Wirewound lamina type fixed resistors

0,15 up to 30 Kilowatt

Wirewound lamina type fixed resistors as individual components, that can be integrated into other units and composed lamina type fixed resistor units in different degrees of protection and mounting types.

- Variable connections at wires, screw clips or terminals, with or without adjustable clips
- In degree of protection IP00 single elements can be combined to units for special requirements
- Up to degree of protection IP20 or IP23 for horizontal and vertical mounting
- Thermal overload relay, temperature switch or FRIZLEN DC-Powerswitch for thermal monitoring and switch off



Contents

This list comprises wirewound lamina type fixed resistors as individual components in type series L and LB that can be integrated into other units. It also includes composed resistor units in different degrees of protection and mounting solutions.

<i>maximum power</i>	<i>characteristics</i>	<i>type series</i>	<i>page</i>
	survey		T512E
	technical details		T513E
1,1 kW	suitable for integration, can be combined	L /LB	T520E
3,0 kW	compact construction form, 2 terminals	FG /FGB /FGL	T524E
3,0 kW	thermal overload relay integrated	FGT /FGBT /FGLT	T525E
4,4 kW	up to 10 terminals possible	FGN /FGBN	T526E
22 kW	version of low noise and low inductance	FGF	T527E
4,5 kW	adjustable clips possible as well as IP 23	FSL /FAL 16..	T529E
30 kW	up to 30 terminals possible as well as IP 23	FSL /FAL 70..	T530E
250 kW	different continuous steps, forced ventilation	FAV /FSV 68..	T531E

Properties

- **low temperature coefficient**
 - ⇒ constant ohmic value over a large temperature range (s. p. T513E)
- **overload resistant at short time load**
 - ⇒ form-locking fixation
- **resistance value adjustable by adjustable clip**
 - ⇒ modification, adjustment or trimming on location (see type description)
- **flat construction form, various lengths and widths**
 - ⇒ can be integrated, various possibilities for connection and mounting (type series L / LB)
- **enclosure made from hot galvanised steel sheet**
 - ⇒ various protection and mounting types (all series besides L / LB)
- **low noise and low inductance version possible**
 - ⇒ used for apartment buildings, hospitals, opera houses and theatres (serialized with series FGF)
- **thermal overload relay available**
 - ⇒ integrated warning for high operating security (serialized with series FGT / FGBT / FGLT / FGFT)
- **intrinsically safe**
 - ⇒ to switch off the resistor safely by FRIZLEN DC POWERSWITCH (type series FGFX)

Applications

- braking resistors for frequency converters and DC drives, in low noise version suitable for hospitals and theatres
- fixed resistors for power packs, batteries, UPS-units, generators
- starting and regulating resistors for slip-ring rotor motors
- starting resistors for DC motors
- stator resistors for squirrel-cage motor
- resistors for current limitation e.g. for charging and discharging of capacitors
- integration into power supply units
- protective resistors



T 500 - survey

type series		L + LB	FG + FGL	FGB	FGT FGBT FGLT	FGN + FGBN	FGF. 610 - 614	FSL 16 - 20	FAL 16 - 20	FSL 70 - 75	FAL 70 - 75	F.V 685 - 688
	characteristics	page Symbol	T520E - T523E	T524E	T524E	T525E	T526E	T527E - T528E	T529E	T529E	T530E	T530E
power from [kW]		0,15	0,25	0,37	0,25	1,5	4,0	0,25	0,25	2,5	2,5	75
power up to [kW]		1,11	3,0	1,5	3,0	4,4	22,0	4,5	4,5	30	30	250
max. number of terminals		-	2	2	2	10	2	12	12	30	30	40
degree of protection IP00		X										
degree of protection IP20 - if mounted on an appropriate surface			X	X	X	X	X					
degree of protection IP20									X		X	X
degree of protection IP23								X		X		X
horizontal mounting			X	X	X	X	X			X	X	X
vertical mounting			X	X	X	X	X	X	X			
mounting not allowed			X	X	X	X	X	X	X			
temperature switch (optional)							X					X
thermal overload relay					X		X					
FRIZLEN DC-POWERSWITCH							X					
adjustable clips possible		X	X			X		X	X	X	X	X
integration possible		X										
forced ventilation												X

Rights for improvements and modifications of our products reserved.
 Modifications, errors and misprints justify no claim for damages.
 We refer to our terms of sales and delivery.



Technical details

Construction

Lamina type fixed resistors consist of support straps, ridged ceramic insulators and of resistor wiring. In standard version the strap is manufactured from a zinc plated steel sheet. We supply it with ridged ceramic insulators, grooved, made of ceramic (steatite C221), 60mm long, with pitches of 2mm, 3mm, 4mm and 5mm. For winding the resistors we use special wires made of CuNi 44 according to DIN 17471, 46460-1 and 46461 made of NiCr 3020 or CrAl 25 5 according to DIN 17470. The wires are fixed by the grooves on the ridged ceramic insulators in a non-slip way, even if they stretch when heated.

Resistance values/ Production tolerance/ Temperature dependency

The resistance values in the column "production range" refer to our standard production range. Other values can be achieved if required. The normal tolerance is $\pm 10\%$. Smaller tolerances upon request.

The resistance value will change slightly in dependency of the winding temperature. With $\Delta T \approx 300$ K the resistance will change compared to a cooled down condition as follows: with wires from CuNi 44 approx. $\pm 1\%$, made of CrAl 25 5 approx. $+1\%$ and made of NiCr 3020 approx. $+10\%$.

Adjustable clips Taps



Lamina type fixed resistors of type series L and LB can be provided with adjustable clips in order to adjust to the resistor values. The same applies to some type series of our composed units. Others can be provided with fixed taps wired on terminals.

Time constant

The medium thermal time constant is 150 s.

Degrees of protection

Correlation of type series and degrees of protection according to EN 60529 and/or DIN VDE 0470 part 1

IP
00

IP
20^①

IP
20

IP
23

Type series	Degree of protection	First digit degree of protection against access & solid foreign objects	Second digit degree of protection against water
L LB FK..	IP 00	Non-protected – i.e. depending upon integration the user must provide a protection	Non-protected
FG.. FGB.. FGF..	IP 20 ^①	Protected against access to hazardous parts with a finger and against solid foreign objects of 12,5mm \varnothing and greater.	Non-protected
FAL.. FAV..	IP 20		Non-protected
FSL.. FSV..	IP 23		Protected against spraying water. Water sprayed at an angle up to 60° on either side of the vertical shall have no harmful effects

^①if mounted on an appropriate surface – i.e. mounted on a surface according to degree of protection IP 20 or higher

Protective measures

All our power resistors of degree of protection IP 20^① or higher correspond to safety class I, i.e. we provide connections for protective earth conductors according to EN 61140.



Devices of degree of protection IP 20 or higher correspond to the CE low voltage directive.

Power resistors being passive electrical or electrical units are not affected by the specific EMC standards. They do not produce any interfering radiations nor are they affected.



Air- and Creepage distance

Air and creepage distances are rated according to IEC 664 (DIN EN 0110 part 1) for the overvoltage category III and degree of pollution 3 for grounded three-phase mains supplies up to 3 x 500 V. Testing voltage 2.5 kV AC. These data are valid for all devices that are connected to mains voltage and derived voltages, as for example the intermediate circuit voltage of frequency converters. Do not conclude from the calculated relation between the rated power and the maximum producible ohmic value to the rated voltage!

Excess current protection

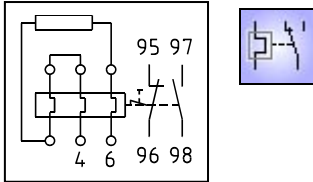

A protection of the resistors against overloading or excess temperature - as demanded in standards - can be realized with the help of a thermal overload relay provided by the user. The set current must correspond to the rated current of the resistor, that is calculated according to continuous duty power and resistance value corresponding to Ohm's law (formula: see "terminal details" p. T517E).

Concerning the series FGT, FGBT, FGLT and FGFT the thermal overload relay is a component of the device - with exceeding of the rated current a signal contact is released. There will not be a disconnection of the resistor. Resetting by hand.

Excess temperature protection

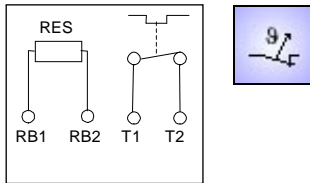

Another kind of the excess temperature monitoring, particularly suited for long-term overloading, is the equipment with a temperature switch. In IP 20/23-resistor devices it is wired on terminals, in IP 00 resistors the switch is directly connectable and releases a signal contact when the set temperature is exceeded. There will not be a disconnection of the resistor. See type series FGF.Q and F.VQ.

You can inform yourselves about function and restrictions by our data sheet „Tripping of monitoring devices“.
We can send it to you on request.

Intrinsically safe version with Frizlen DC-POWERSWITCH

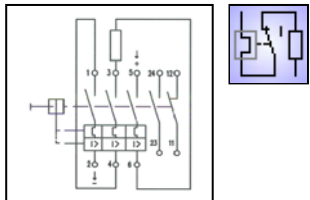

Integrated overload switch for a maximum of 850 VDC to protect the resistor. It protects the integrated resistor against constant overload and against too high short time peak power, e.g. caused by a false operational mode or a fault by an short circuited chopper transistor. Possible damage in the environment by overheating and burning are effectively avoided.

So you receive an intrinsically safe resistor protection degree even for IP20[®]. The FRIZLEN DC-POWERSWITCH can also be integrated in the switch cabinet. After a successful fault clearance the DC-POWERSWITCH can be switched on like a normal automatic cutout. We can send you more technical details and characteristics on request.

Attention: Frizlen DC-POWERSWITCH are only suited for monitoring and disconnecting from DC-voltage with pure resistive load (DC1) up to 850 VDC.

Contact rating

Contact ratings of the signal contacts of temperature switches and thermal overload relays.

- 2 A / 24 VDC (DC11)
- 2 A / 230 VAC (AC11)

Contact ratings of the signal contacts of the DC-Powerswitch:

- 5 A / 24 VDC (DC11)
- 10 A / 230 VAC (AC11)

Storage temperature/ Operation temperature/ Installation altitude

Storage temperature: - 40° C to 80° C
Operation temperature: - 30° C to 40° C. If the ambient temperature is higher than 40°C, you have to decrease the continuous dissipation by 4% per 10 K temperature rise!

Installation altitude: 2000 m above sea level, you have to decrease the continuous dissipation for 10% per 1000 m altitude, maximum altitude 5000 m above sea level

Restrictions are to be made for the type series FGFT. and FGFX. because of the built-in monitoring device. Operation temperature: - 20° C to 40° C.



*Ventilation /
Temperatures*

The given typical power values are valid for 100% duty cycle factor (DCF) (continuous dissipation) under the following conditions:

- temperature rise of 200 K at the surface of fixed resistor enclosures (degree of protection > IP00)
- temperature rise of 300 K at the surface of fixed resistor elements (degree of protection IP00).
- unhindered access of cooling air
- unhindered diverting of warmed up air (mind a minimum separation distance of approx. 200 mm to neighbouring components/walls and of approx. 500 mm to components above/ceiling)

Since electrical energy is converted into heat, heating up of the exhaust air and of the enclosure at the air outlet is inevitable.

The highest temperature with typical power may be maximum 200°C above the ambient temperature. Since the cooling of the devices is accomplished by convection and/or forced ventilation (series FAV/ FSV), the above mentioned aspects have absolutely to be considered.



In cases of insufficient cooling or false mounting the resistor or the surrounding construction units could be overheated or ruined.

Depending upon use it can be possible to increase the continuous dissipation of the resistors, if higher temperatures are accepted. With an increase of e.g. 130% of the typical power you will have a rise in temperature of 350K at the surface of the resistor. In other cases of application the continuous dissipation must be reduced, for example with temperature sensitive devices in the surrounding area. The dependence between temperature rise and actual continuous dissipation is shown in the diagram below.

Excess temperature in dependence of continuous dissipation

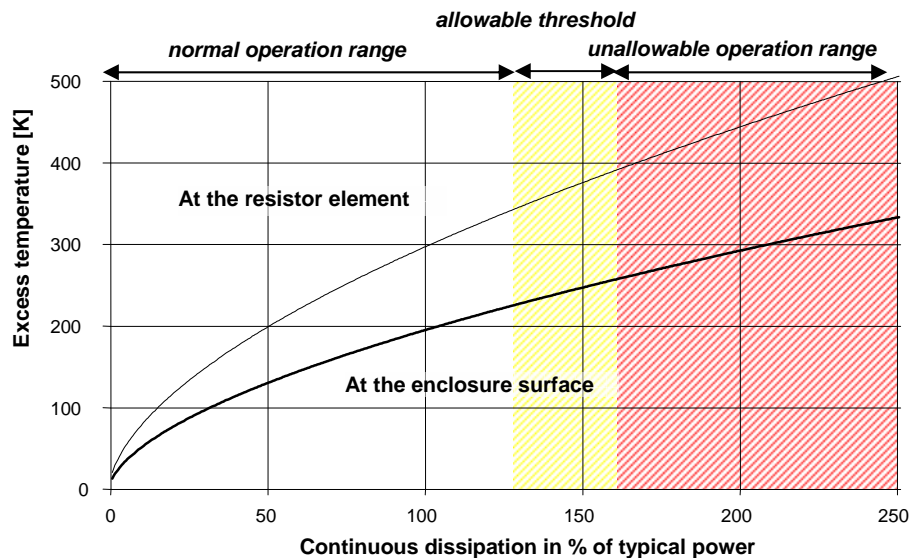

Normal operation range (up to 130%):

Recommended operation range for maximum product life and failure free operation

Allowable threshold (up to 160%):

Allowable operation range, danger of shorter product life and higher failure probability

Unallowable operation range (more than 160%):

Danger of excessive heat and destruction of resistor and neighbouring components



Short time dissipation/
Total cycle time/
Duty cycle factor(DCF)

At many applications resistors are not loaded in continuous but in short time operation. In the following you will find indications, how to calculate the allowable short time dissipation with the help of the duty cycle factor (DCF) and the overload factor (OLF). If the DCF factor is not known, it can be calculated as follows:

$$\text{Duty cycle factor(DCF)} = \frac{\text{Switch on time}(t_{on})}{\text{Total cycle time}}$$

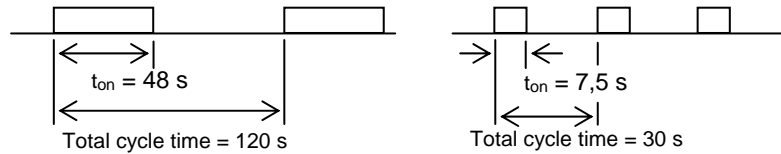

$$ED_1 = \frac{48s}{120s} = 0,4 = 40\%$$

$$ED_2 = \frac{7,5s}{30s} = 0,25 = 25\%$$

warning: The total cycle time may be maximum 120 s - shorter total cycle times are possible.
The total cycle times for motors are mostly higher than 120 s

Overload factor (OLF)

By comparison of the known DCF-factor with the following diagram or table you can work out the overload factor (OLF) and/or the continuous and the short time dissipation.

Overload factor (OLF) in dependence of duty cycle factor (DCF)
(Total cycle time = 120s)

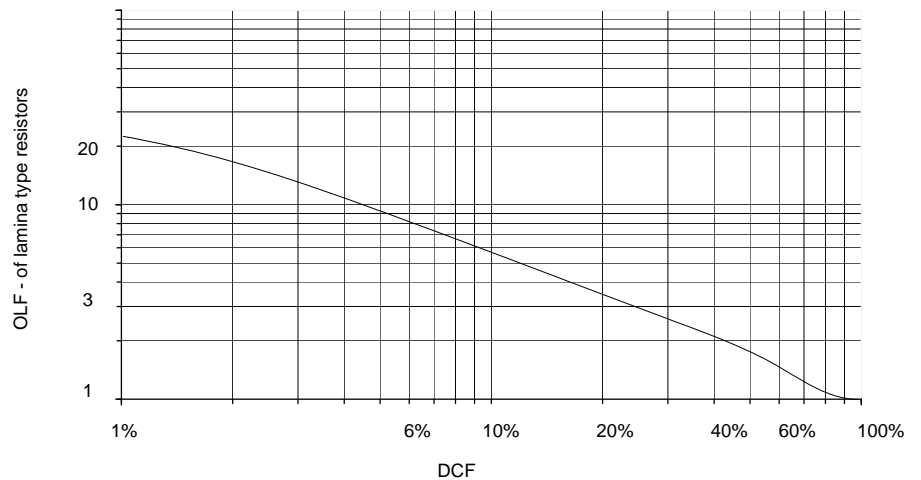

	1%	3%	6%	15%	25%	40%	60%	80%	100%
ED									
ÜF	22	13	8,2	4,2	3,0	2,2	1,5	1,12	1,0

The continuous and the short time dissipation can be calculated as follows:

$$\text{Short time dissipation} = \text{Continuous dissipation} \times \text{OLF}$$

$$\text{Continuous dissipation} = \frac{\text{Short time dissipation}}{\text{Overload factor(OLF)}}$$

Calculation example
given:

wanted:
continuous dissipation

- Resistor with a short time dissipation of 50 kW for 30 s and a total cycle time of 120s
- The duty cycle factor (DCF) is 30 s : 120 s x 100% = 25%
- Overload factor (OLF) for 25% DCF, according to table it is 3,0
- The continuous dissipation is 50 kW : 3,0 = 16,7 kW;
- ⇒ You need a resistor with a continuous dissipation of at least 16,7 kW!



*Terminal details/
Monitoring devices/
Cross section*

Rated current and cross section of terminals and monitoring types.

Type	abbreviation	rated current in A with 100% DCF	rated current in A with 40% DCF	maximum cross section
porcelain terminal	PK	16		up to 2,5 mm ²
ceramic flat terminal	FK	35	44	2,5 - 10 mm ²
device terminal out of Polyamid (PA)	G 5	30	38	0,5 – 2,5 (4) mm ² AWG 24 - 12
	G 10	60	75	0,5 – 10 (16) mm ² AWG 20 - 6
bolt terminals out of ceramic	BK M6	60	75	cross section depending on lug size with corresponding hole
	BK M8	115	143	
	BK M10	220	287	
	BK M12	400	536	
cage clamp terminal out of PA	ST2,5	20	25	up to 2,5 mm ² ; AWG 16 - 12
	ST 4	30	38	up to 4,0 mm ² ; AWG 20 – 10
thermal overload relay	signal contact	2	-	up to 2,5 mm ² ; AWG 16-12
	main connection	bis 13/24/80	17/30/100	2,5/4/25 mm ² ; AWG 20 - 6
DC-POWER-SWITCH FPS	signal contact	10	-	up to 1,5 (2,5) mm ² ; AWG 16 - 12
	main connection	40	50	up to 16 mm ² ; AWG 4

The values in the brackets are valid for solid conductor or single wired.

The rated current is calculated in each case due to Ohm`s law as follows:

$$I = \sqrt{\frac{P}{R}}$$

whereas
P is the power of the resistor and
R is the value of the resistance

Wiring

If terminals are required, the connections are wired by means of flexible, heat resistant, silicone-insulated wire on a terminal strip that is located in the lower and/or front part of the equipment within the area of the entering cooling air. If the wiring is accomplished by the user, make sure that a heat resistant wire is used.

With the series F.L 7.. as well as with F.V 68.. there is an undrilled cable entry strip in the lower part. It can be provided by the user with appropriate drillings for cable glands as strain relief.

Mounting

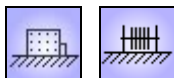

Allowable: On horizontal surfaces

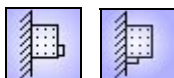

Allowable: On vertical surfaces terminals at the bottom

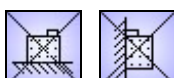

Not allowable: On vertical surfaces terminals at the top, left or right



Allowable: On vertical surfaces



Type series L / LB

150 – 1110 W with connection at wires, lugs or screw clips

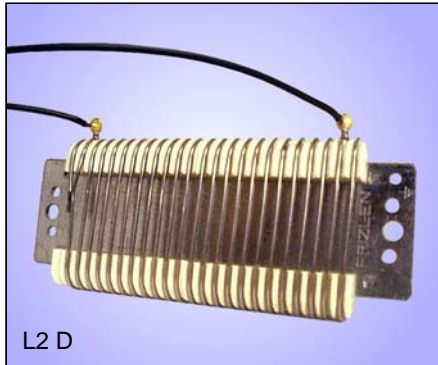

Wirewound lamina type fixed resistors, degree of protection IP 00 with ridged ceramic insulators from steatite. Standard version with straps from zinc plated steel in

2 widths: type series L.. (standard version)
type series LB.. (wide version)

Technologies

- particularly flat design
- suitable for integration
- assembled units possible
- various lengths and widths, therefore many specifications depending on requirement
- continuous dissipation up to 1110 W
- adjustable clips are available for both type series

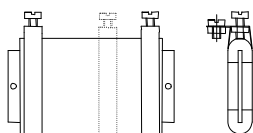
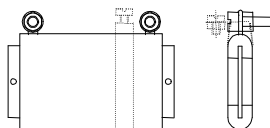
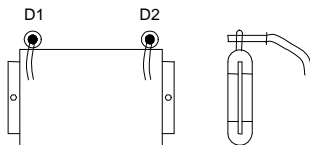

Connection types and versions

We provide three versions with various connection types

- With wires, version L.. D and LB.. D
- With lugs and connecting screws, version L.. and LB..
- With screw clips, version L.. C and LB.. C

The last two can also be provided with adjustable clips

Version L.. D and LB.. D

lamina type fixed resistors with connection at 2 hard soldered wires. Standard version (if no other data): Silicone insulated wire (SIF), cross section 1,5 mm², length of wires D1 and D2 500 mm each. Suitable for all resistance values.

Version L.. and LB..

lamina type fixed resistors with 2 wire lugs as connection points, which are provided with M5 screw combinations for the connection. Only suitable for resistance wires from cross section 0,8 mm on!

Version L.. F and LB.. F

With one or several adjustable clips, that can be modified (F, 2F, 3F, 4F)
Example: LB5 2F- 21, wide lamina LB5 with 2 adjustable clips and 21 Ω.

Version L.. C and LB.. C

lamina type fixed resistor with 2 screw clips as end clips, that are prepared with M5 screw combinations for the connection. Suitable for all resistance values.

Version L.. C.F and LB.. C.F

With one or several adjustable clips, that can be modified (CF, C2F, C3F, C4F)
Example: L10 CF - 150, standard lamina L10 with 1 adjustable clip and 150 Ω.

Application

- brake resistor
- load resistor
- protection resistor

Special versions of the support strap

- from aluminium or stainless steel for a low noise and low inductance version
- from zinc plated perforated steel sheet for a better ventilation when incorporated horizontally or into units with forced ventilation.
- With special dimensions to perfectly suit the requirements of the application



Type series L / LB

Options to perform the connection wires for version L..D, LB..D

1. Insulation and cross section of wires

In standard version wires are silicone insulated (SIF) with a cross section of 1,5 mm², colour black
 Continuous temperature +180°C (for a short time 200°C)
 We can deliver the following variations with additional charge:

- Silicone insulated wire cross section 2,5 mm², colour black (only available for resistance wires from diameter 1,2mm on)
- Teflon insulated wire FEP (silicone free), cross section 1,5 mm², colour transparent, continuous temperature 205°C
- Teflon insulated wire FEP/UL, UL approved (UL 1330), cross section AWG14 (equal to 2,08 mm²), colour white with UL-print, continuous temperature 200°C
- silicone- and Teflon free wire name brand Radox 155, UL approved (UL 3298), cross section AWG14, colours yellow, red or blue, continuous temperature 155°C

2. Lengths of wires

In standard version wires D1 and D2 are both 500 mm long , but can be modified and provided in various lengths.

3. Equipment of the open wire endings (connection provided for the customer)

In standard version wires are not bared and not equipped with connection devices. For an additional charge we provide:

- lugs M4 or M5, blank or insulated with heat shrink tubing
- fast-on connections 6,3 x 0,8 straight or angled, blank or with enclosure
- conductor sleeves, blank
- bi- or multi-pole plugs for easy connection by the user

4. Resistor taps

For special applications we provide further connection wires as fixed taps.

5. How to order

If you want to modify our standard version please specify the connection wires as follows (example):

wire D1 : Radox 155 – Insulation, AWG 14, 300 mm long, yellow, with conductor end sleeve blank

wire D2 : Radox 155 – Insulation, AWG 14, 400 mm long, blue, with fast-on connection 6,3 x 0,8 blank, straight

Combinations of several lamina type fixed resistors to form a unit

- Several laminas can be combined by brackets or threaded bolts to form units ready to connect and to integrate
- By a range of enclosures or partial enclosures we provide all kinds of ducts for better ventilation and screening against heat sensitive parts

Examples of constructions

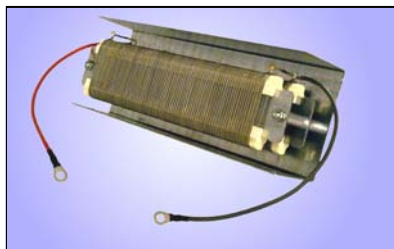

- Unit consisting of 2 paralleled laminas L4
- The laminas are combined by threaded bolts to a unit
- Three-side cover, can be used for mounting
- Wire connection and lugs M5 (with heat shrink tubing)

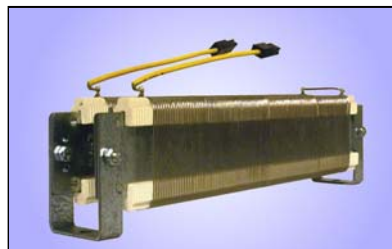

- Unit consisting of 2 laminas L4 connected in series
- The laminas are combined by brackets to a unit
- Wire connection with straight fast-on connection 6,3 x 0,8 in an enclosure

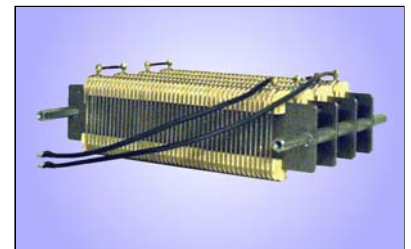

- Unit consisting of 4 laminas L3 connected in series
- The laminas are combined by threaded bolts to units
- Wire connection and lugs M4 (with heat shrink tubing)



Type series L

The selection of the windings below is based upon economical aspects. Other windings with an increased weight of the wire for better energy absorption capacity or different ohmic values on request. The given power in W refers to individual mounting, ventilation and unhindered access of air for 100% DCF (continuous dissipation). The power has to be reduced by the factor 1,21 when several laminae are combined or when integrated into an enclosure.

type		L2	L3	L4	L5	L6	L7	L8	L9	L10	
power [W] at 40°C and 100% ED		150	235	300	380	460	535	610	690	760	
Dimension A [mm]		140	210	260	340	390	445	520	560	620	
Dimension B [mm]		155	225	275	355	405	460	535	575	635	
alloy	type of resistor wire Ø [mm]	pitch of ridged ceramic insulators [mm]	resistance values in Ω								
CrAl 25 5	0,5	2	54	84	115	145	176	207	237	268	299
CrAl 25 5	0,55	2	45	70	96	121	147	172	198	223	249
CrAl 25 5	0,6	2	38	60	81	102	124	145	167	188	210
CrAl 25 5	0,65	2	32	50	68	86	104	122	140	158	177
NiCr 30 20	0,6	2	28	43	58	73	90	104	120	135	150
NiCr 30 20	0,65	2	24	36	49	62	76	89	103	115	128
NiCr 30 20	0,7	2	20	31	43	54	66	77	89	100	111
NiCr 30 20	0,75	2	18	27	37	47	57	67	77	87	96
NiCr 30 20	0,8	2	16	24	33	41	50	59	68	76	85
CuNi 44	0,6	2	12	20	27	34	41	49	56	63	71
CuNi 44	0,65	2	11	17	23	29	35	42	48	54	60
CuNi 44	0,7	2	9,2	14	20	25	30	36	41	46	52
NiCr 30 20	0,9	3	8,0	13	17	22	26	31	36	40	45
NiCr 30 20	1,0	3	6,4	10	14	18	21	25	29	32	36
NiCr 30 20	1,1	3	5,4	8,4	12	15	18	21	24	27	30
NiCr 30 20	1,2	3	4,5	7,1	9,7	13	15	17	20	23	25
CuNi 44	0,9	3	3,8	5,9	8,1	10	12	14	16	19	21
CuNi 44	1,0	3	3,1	4,8	6,6	8,3	10	11	13	15	17
CuNi 44	1,1	3	2,5	4,0	5,4	6,9	8,3	9,8	11	12	14
CuNi 44	1,2	3	2,1	3,3	4,6	5,8	7,0	8,2	9,4	10	11
CuNi 44	1,3	3	1,9	2,9	4,0	5,0	6,1	7,1	8,2	9,2	10
CuNi 44	1,4	3	1,5	2,5	3,3	4,2	5,1	6,0	6,9	7,8	8,7
CuNi 44	1,3	4	1,4	2,2	3,0	3,8	4,6	5,4	6,2	7,0	7,8
CuNi 44	1,4	4	1,2	1,9	2,5	3,2	3,9	4,5	5,2	5,9	6,5
CuNi 44	1,5	4	1,0	1,6	2,2	2,8	3,4	4,0	4,5	5,1	5,7
CuNi 44	1,6	4	0,92	1,4	2,0	2,5	3,0	3,5	4,0	4,5	5,0
CuNi 44	1,7	4	0,83	1,3	1,8	2,2	2,7	3,1	3,6	4,1	4,5
CuNi 44	1,6	5	0,73	1,1	1,5	2,0	2,4	2,8	3,2	3,6	4,0
CuNi 44	1,7	5	0,65	1,0	1,4	1,8	2,1	2,5	2,9	3,2	3,6
CuNi 44	1,8	5	0,57	0,89	1,2	1,5	1,9	2,2	2,5	2,8	3,2
CuNi 44	1,9	5	0,52	0,81	1,1	1,4	1,7	2,0	2,3	2,6	2,9
CuNi 44	2,0	5	0,46	0,72	0,98	1,2	1,5	1,8	2,0	2,3	2,6

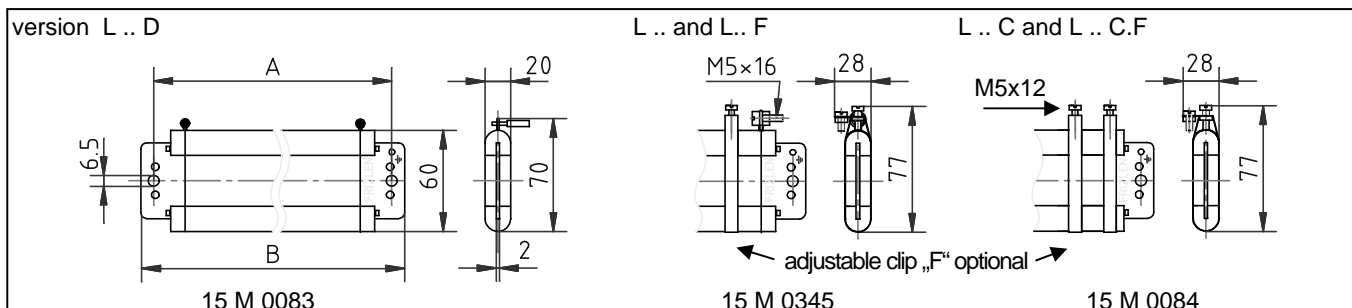

Example of dimensioning and selection of a special unit:

lamina type fixed resistor 380 W , resistance value 10 Ω,
with connection at screw clips, with an additional adjustable
clip: selected: L 5 CF – 10

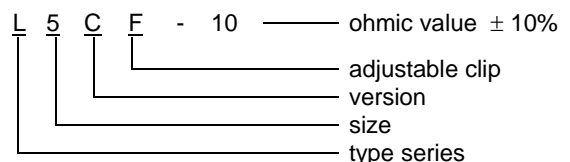



Type series LB

The selection of the windings below is based upon economical aspects. Other windings with an increased weight of the wire for better energy absorption capacity or different ohmic values on request. The given power in W refers to individual mounting, ventilation and unhindered access of air for 100% DCF (continuous dissipation). The power has to be reduced for the factor 1,21 when several laminae are combined or when integrated into an enclosure.

type			LB2	LB3	LB4	LB5	LB6	LB7	LB8	LB9	LB10
power [W] at 40°C and 100% ED			220	345	445	555	665	785	895	1000	1110
dimension A [mm]			140	200	260	320	380	440	500	560	620
dimension B [mm]			155	215	275	335	395	455	515	575	635
alloy	Type of resistor wire		resistance values in Ω								
	∅ [mm]	pitch of ridged ceramic insulators [mm]									
CrAl 25 5	0,8	3	21	32	44	56	68	80	92	103	115
CrAl 25 5	0,9	3	16	26	35	44	53	63	72	81	91
CrAl 25 5	1,0	3	13	21	28	36	43	51	59	66	74
NiCr 30 20	0,9	3	12	18	25	32	39	45	52	59	66
NiCr 30 20	1,0	3	9,5	15	20	26	31	37	42	47	53
NiCr 30 20	1,1	3	7,8	13	17	21	26	30	35	39	44
NiCr 30 20	1,2	3	6,6	11	14	18	22	25	29	33	37
CuNi 44	0,9	3	5,5	8,7	11	15	18	21	24	28	31
CuNi 44	1,0	3	4,4	7,0	9,5	12	14	17	20	22	25
CuNi 44	1,1	3	3,7	5,8	7,9	10	12	14	16	18	21
CuNi 44	1,2	3	3,1	4,9	6,7	8,4	10	12	13	15	17
CuNi 44	1,3	3	2,7	4,2	5,8	7,3	8,9	10	12	13	15
CuNi 44	1,4	3	2,3	3,6	4,9	6,2	7,5	8,8	10	11	12
CuNi 44	1,3	4	2,1	3,2	4,4	5,6	6,7	7,9	9,0	10	11
CuNi 44	1,4	4	1,8	2,7	3,7	4,7	5,7	6,6	7,6	8,6	9,6
CuNi 44	1,5	4	1,5	2,4	3,2	4,1	4,9	5,8	6,6	7,5	8,3
CuNi 44	1,6	4	1,3	2,1	2,9	3,6	4,4	5,1	5,9	6,6	7,4
CuNi 44	1,7	4	1,2	1,9	2,6	3,3	3,9	4,6	5,3	6,0	6,6
CuNi 44	1,6	5	1,0	1,7	2,3	2,9	3,4	4,0	4,6	5,8	5,8
CuNi 44	1,7	5	0,95	1,5	2,0	2,6	3,1	3,7	4,2	4,7	5,3
CuNi 44	1,8	5	0,83	1,3	1,8	2,3	2,7	3,2	3,7	4,2	4,6
CuNi 44	1,9	5	0,76	1,1	1,6	2,1	2,5	2,9	3,4	3,8	4,2
CuNi 44	2,0	5	0,67	1,0	1,4	1,8	2,2	2,6	3,0	3,4	3,7

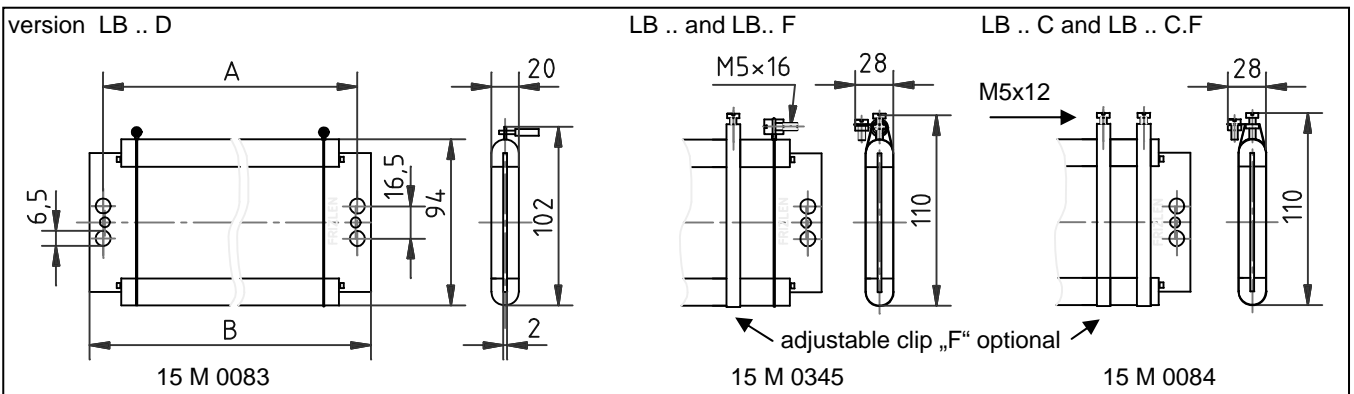

Example of dimensioning and selection of a special unit:

lamina type fixed resistor 1000 W ,resistance value 15 Ω, with connection at 2 hard soldered joint wires of following lengths: wire D1 = 800 mm and wire D2 = 1000 mm, version with silicone insulated wire, cross section 1,5 mm² selected: LB 9 D – 15, wire D1: 800; wire D2: 1000

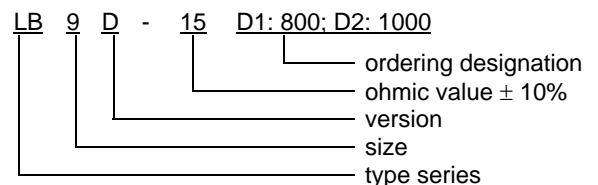



Type series FG / FGB / FGL

0,25 – 3,0 kW with 2 terminals



FG 6



Wirewound lamina type fixed resistor, degree of protection IP 20^① in zinc plated steel sheet enclosure with 2 terminals and PG11-cable gland in attached terminal box.

^① mounted on an appropriate surface

Technologies

- flat construction form
- continuous dissipations up to 3,0 kW
- Wall mounting or mounting on the switch cabinet
- adjustable clips available for all type series, besides FGB
- up to 20A 2-pole porcelain terminal
- up to 35A 2-pole flat terminal

The given power rating values are valid for 100% DCF (continuous dissipation). For short time operation you will find the values in the following table as a function of the duty cycle factor (DCF). Just multiply by the corresponding overload factor (OLF).

ED	60%	40%	25%	15%	6%
ÜF	1,5	2,2	3,0	4,2	8,2

These overload factors are valid for a total cycle time of maximum 120 s.

You will find further details in chapter Technical Details, pages T513E - T517E.

There are various applications for wall mounting or mounting on the switch cabinet because of the flat and compact construction.

An important application is the use as braking resistor for motor/generator drive of motors with frequency converters.

Special design

- Version of low inductance and low noise (support strap from aluminium or stainless steel)
- version with degree of protection IP00 type series FK / FKB / FKL on request

Electrical and mechanical data

type	power in kW at 40°C and 100% DCF	production range Ω-value		number of laminas and size	dimensions in mm					max. weight in kg
		from	up to		L	M	R	U	O	
FG 2	0,25	0,23	40	2 L2	140	184	92	64	240	1,3
FG 3	0,39	0,36	62	2 L3	210	254	92	64	310	1,7
FG 4	0,50	0,49	86	2 L4	260	304	92	64	360	2,4
FG 5	0,63	0,62	100	2 L5	340	384	92	64	440	2,6
FG 6	0,75	0,75	130	2 L6	390	434	92	64	490	2,8
FG 7	0,90	0,90	150	2 L7	445	489	92	64	545	3,0
FG 8	1,00	1,0	170	2 L8	520	564	92	64	620	3,5
FGB 2	0,37	0,34	24	2 LB2	140	184	92	64	240	1,5
FGB 3	0,57	0,53	36	2 LB3	200	254	92	64	310	1,9
FGB 4	0,74	0,72	50	2 LB4	260	304	92	64	360	2,6
FGB 5	0,92	0,90	64	2 LB5	320	364	92	64	420	2,8
FGB 6	1,10	1,1	78	2 LB6	380	434	92	64	490	3,0
FGB 7	1,30	1,3	90	2 LB7	440	489	92	64	545	3,4
FGB 8	1,50	1,5	100	2 LB8	500	544	92	64	600	4,0
FGL 640402	1,00	1,0	170	4 L4	260	300	185	150	360	4,0
FGL 660402	1,50	1,5	260	4 L6	390	430	185	150	490	5,0
FGL 680402	2,00	2,0	350	4 L8	520	560	185	150	620	6,0
FGL 660602	2,20	2,2	390	6 L6	390	430	275	240	490	7,0
FGL 680602	3,00	3,0	530	6 L8	520	560	275	240	620	9,0

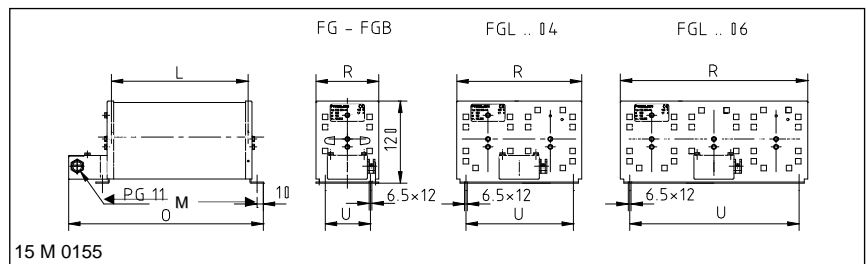

Example of dimensioning and selection of a specific unit:

Monophase braking resistor for drive with frequency converter, short time power: 8 kW at 6% DCF, total cycle time shorter than 120 s, intermediate circuit voltage 650 V; resistance value 50 Ω; Calculation of the continuous dissipation: 8kW : 8,2 = 0,98 kW. selected: FG 8 – 50 with continuous dissipation 1kW

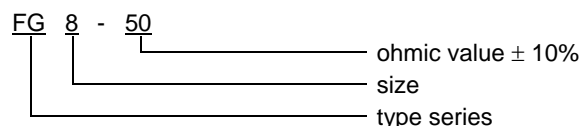



Type series FGT / FGBT / FGLT

0,25 – 3,0 kW with 2 terminals

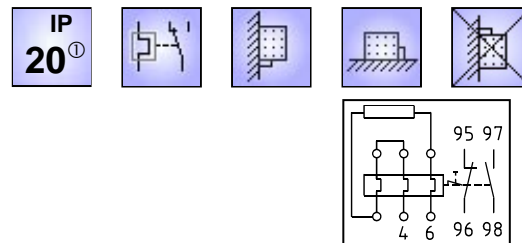
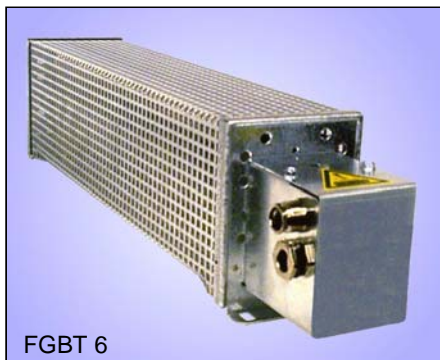

Wirewound lamina type fixed resistor, degree of protection IP 20^① in zinc plated steel sheet enclosure. Cable glands and as well as thermal overload relay in attached terminal box.

^① mounted on an appropriate surface

Technologies

- integrated thermal overload relay up to 24 A
- with thermal protection
- connections directly at the overload relay
- current is adjusted
- Wall mounting or mounting on the switch cabinet

Thermal overload relay

The thermal overload relay is mounted in the attached terminal box and may signal an overloading of the resistor. This is done by contacts normally closed/opened free of potential (NC/NO). This signal has to be considered by the customer, e.g. by warning or net side disconnection.

Warning: There will not be a disconnection of the resistor!

Cross sections / cable glands:

fine stranded, for relays up to	connection in mm ²	
	13A	24A
main current	1 x 2,5	2 x 6
auxiliary curr.	1 x 2,5	2 x 2,5
Cable glands	PG9 + PG11	M12 + PG16

Contact rating of the signal contacts:

- 2 A / 24 VDC (DC11)
- 2 A / 230 VAC (AC11)

Application

Braking resistors for motor/generator drive of motors with frequency converters with monitoring of the current.

Special design

- Version of low inductance and low noise (support strap from aluminium or stainless steel)

Electrical and mechanical data

type	power in kW at 40°C and 100% DCF	production range Ω-value		# of lamina and size	dimensions in mm						max. weight in kg
		from	up to		L	M	R	U	overload relay up to		
									13A	24A	
FGT 2	0,25	0,2	40	2 L2	140	184	92	64	260	293	1,9
FGT 3	0,39	0,3	62	2 L3	210	254	92	64	330	363	2,3
FGT 4	0,50	0,4	86	2 L4	260	304	92	64	380	413	3,0
FGT 5	0,63	0,6	100	2 L5	340	384	92	64	460	493	3,2
FGT 6	0,75	0,7	130	2 L6	390	434	92	64	510	543	3,4
FGT 7	0,90	0,9	150	2 L7	445	489	92	64	565	598	3,7
FGT 8	1,00	1,0	170	2 L8	520	564	92	64	640	673	4,1
FGBT 2	0,37	0,4	24	2 LB2	140	184	92	64	260	293	2,1
FGBT 3	0,57	0,6	36	2 LB3	200	254	92	64	330	363	2,5
FGBT 4	0,74	0,8	50	2 LB4	260	304	92	64	380	413	3,2
FGBT 5	0,92	0,9	64	2 LB5	320	364	92	64	440	473	3,4
FGBT 6	1,10	1,1	78	2 LB6	380	434	92	64	510	543	3,6
FGBT 7	1,30	1,3	90	2 LB7	440	489	92	64	565	598	4,0
FGBT 8	1,50	1,5	100	2 LB8	500	544	92	64	620	653	4,6
FGLT 640402	1,00	1,0	170	4 L4	260	300	185	150	380	413	4,6
FGLT 660402	1,50	1,5	260	4 L6	390	430	185	150	510	543	5,6
FGLT 680402	2,00	2,0	350	4 L8	520	560	185	150	640	673	6,6
FGLT 660602	2,20	2,2	390	6 L6	390	430	275	240	510	543	7,6
FGLT 680602	3,00	3,0	530	6 L8	520	560	275	240	640	673	9,6

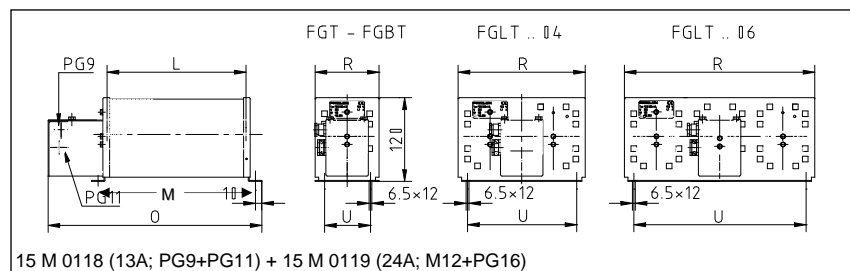

Example of dimensioning and selection of a specific unit:

Monophase braking resistor for drive with frequency converter, short time power: 8,4 kW at 15% ED, , total cycle time shorter than 120 s, intermediate circuit voltage 650V; resistance value 50 Ω; calculation of the continuous dissipation: 8,4 kW : 4,2 = 2 kW selected: FGLT 680402 – 50 with continuous dissipation 2 kW

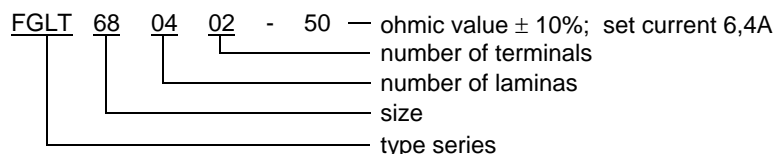

Type series FGN / FGBN

0,5 – 4,4 kW with up to 10 terminals



Wirewound lamina type fixed resistor, degree of protection IP 20[Ⓛ] in fixed condition, in zinc plated steel sheet enclosure with ceramic insulated flat terminals up to 35 A and ceramic insulated bolt terminals for higher currents inside the device. With drillings for 3 cable entry points PG 13,5, which are closed by rubber sockets.

[Ⓛ] mounted on an appropriate surface

Technologies

- Continuous dissipation up to 4,4 kW
- Wall mounting and mounting on the switch cabinet
- Up to 10 terminals possible
- Adjustable clips possible

The connections are accessible after demounting a part of the cover.

FGBN-version is equipped with wider laminas and therefore suited for higher power ratings.

The given power rating values are valid for 100% DCF (continuous dissipation). For short time operation you will find the values in the following table as a function of the duty cycle factor (DCF). Just multiply by the corresponding overload factor (OLF).

ED	60%	40%	25%	15%	6%
ÜF	1,5	2,2	3,0	4,2	8,2

These overload factors are valid for a total cycle time of maximum 120 s

You will find further details in chapter Technical Details, pages T513E-T517E.

The number of terminals is determined by position 5 and 6 of the type designation.

Application

- Three-phase load resistors
- Starting and regulating resistors for three-phase slip-ring rotor motors
- current limiting resistors for three-phase squirrel-cage motor

Special design

- version with degree of protection IP00 type series FKN / FKBN. The dimensions are identical with FGN / FGBN

Electrical and mechanical data

type	power in kW at 40°C and 100%DCF	production range Ω -value (single-phase)		max. number of lamina and size	maximum # of terminals in dependency of the size		
		from	up to		FK – flat terminals	BK – bolt terminals	
					FK	BK M6	BK M8
FGN 6406..	1,5	1,5	250	6 L4	10 pcs..	8 pcs.	7 pcs.
FGBN 6406..	2,2	2,2	150	6 LB4	max.	max.	max.
FGBN 6606..	3,3	3,3	230	6 LB6	35A	60A	115A
FGBN 6806..	4,4	4,5	310	6 LB8			

type	dimension in mm		weight in kg
	A	B	
FGN 6406..	400	350	7,0
FGBN 6406..	400	350	9,0
FGBN 6606..	517	470	11
FGBN 6806..	634	580	14

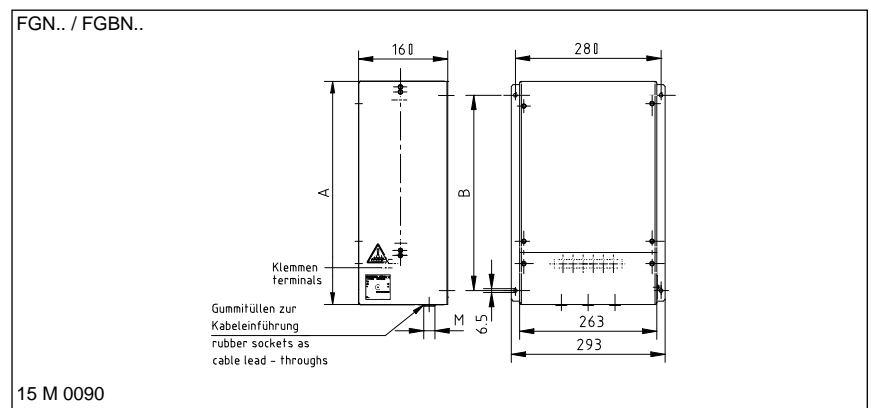

Example of dimensioning and selection of a specific unit:

Three-phase load resistor 3 x 1,4 kW = 4,2 kW for 3 x 230/400 V; 50 Hz; 3 x 6,1 A; 3 x 38 Ω , each phase wired on 2 flat terminals 35 A.

selected: FGBN 680606 – 3 x 38 with continuous dissipation 4,4 kW

FGBN 68 06 06 - 3 x 38 — ohmic value \pm 10%
 — number of terminals
 — number of laminas
 — size
 — type series



Type series FGF.. 61..

1,0 – 22 kW with 2 terminals



Wirewound lamina type fixed resistor, degree of protection IP 20^①, in zinc plated steel sheet enclosure, with max. 2 terminals in different form for the resistor and optional 2 terminals for temperature switch, either in the housing or in an attached terminal box, with optionally integrated thermal overload relay or DC-Powerswitch. In low induction and low noise version by support straps of aluminium. Chart with type selection on the next page.

^① mounted on an appropriate surface

Technologies

- low induction and low noise
- big weight of wire, therefore, high energy absorption capacity
- extremely compact construction form
- continuous dissipation up to 22 kW
- for mounting on the switch cabinet
- for wall mounting, perforated steel sheet at top and bottom, terminals at bottom
- type and size of terminals are selectable according to the mounting place and connections technics in the matrix
- optional with temperature switch (type FGF.Q*)
- optional with thermal overload-relay (type FGFT)
- optional in intrinsically safe version with FRIZLEN DC-POWERSWITCH^② (type FGFX)

Application

This unit are fitting especially for mounting on, beside or in a switch cabinet by their relatively flat and compact construction in 5 widths with various connections and monitoring possibilities (Please mind the description of the types).

An important application is the use as braking resistor for motor/generator drive of motors with frequency converter with low noise for elevators and lifts in apartment houses and hospitals or hoists in theatre and opera house.

You will find further indications for dimensioning of a resistor for short time dissipation in chapter Technical Details pages T513E up to T517E.

Remark

When resistor is integrated into a switch cabinet we recommend to provide a corresponding forced ventilation by the user for better removal of larger dissipations.

Description of the different types

Type FGFQ:

Version with 2 flat type terminals up to max. 35 A rated current in the attached terminal box with cable gland. An additional temperature switch is not possible.

Type FGFK(Q*):

Version like FGFQ, with a bigger attached terminal box with cable glands, the space is sufficient for 2 terminals up to M8 (max. 115 A rated current), and for 2 additional porcelain terminals for an optional temperature switch (FGFKQ).

Type FGFL(Q*):

Version, where all terminals are mounted on the terminal strip inside the housing. Terminals up to M8 (max. 115 A rated current) are accessible after disassembling a part of the cover. If equipped with temperature switch, there are 2 additional porcelain terminals on the terminal strip (Type FGFLQ).No cable glands.

Type FGFT:

Version with integrated thermal overload relay in the attached terminal box with cable glands up to max. 80 A rated current. With integrated short-circuit and overload signalling. Connection directly at the overload relay.

Type FGFX:

Intrinsically safe version with integrated FRIZLEN DC-POWERSWITCH in the attached terminal box with cable glands, up to max. 40 A rated current. With integrated short-circuit and overload protection inclusive switching off the resistor and signalling. Connection directly at the FRIZLEN DC-POWERSWITCH^②.

^②DGBM Nr. 20 2009 015 851.9

Attention: Only for DC voltage up to 850 VDC.

Rated current and cross section of terminals and devices

See technical details on page T517E.

* Remark to the types FGFQK and FGFLQ with temperature switch: The maximum number of lamina type resistors has to be reduced by 2 for all 5 widths of housing.

Monitoring options of the type series FGF.. 61..

1,0 – 22 kW with 2 terminals

1. Signalling–no disconnection!

This warning has to be considered by the customer, e.g. by a warning or disconnection of the mains through the customer. Details, on page T514E.

1a) with temperature switch (FGF.Q)

Different types can be equipped for temperature monitoring with a temperature switch which monitors an overloading of the resistor by a normally closed contact free of potential (NCC).

Connections pls. look at picture 1a)

1b) with thermal overload relay (FGFT)

An eventual overload of the resistor is monitored by the thermal overload relay which is mounted in the attached terminal box. This is accomplished by NCC and NOC contacts. Also for signalling high short time peak power.

Connections pls. look at picture 1b)

Pic. 1a)

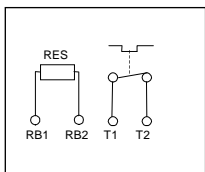

P 1b)

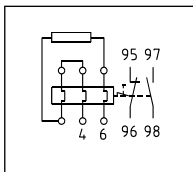

2. Disconnecting and signalling!

with FRIZLEN DC-POWERSWITCH (FGFX) up to 850 VDC up to 40 A

This type series with integrated overload switch in the attached terminal box is able to protect the integrated resistor from constant overload and from too high short time peak power, e.g. caused by a false operational mode or a fault by an short circuited chopper transistor.

This option for protection not only signals the hardware default, it switches off the object / the resistor absolutely reliable! Possible damage in the environment by overheating and burning are effectively avoided.

After a successful fault clearance the DC-Powerswitch can be switched on like a normal automatic cutout.

Connections pls. look at picture

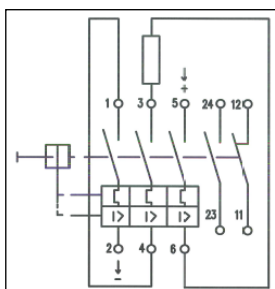

Decision matrix

type	FGFG	FGFK	FGF KQ	FGFL	FGF LQ	FGFT	FGFX
properties							
with temperature - switch (TS)			X		X		
thermal overload relay (up to max. 80 A rated current)						X	
with FRIZLEN DC - POWERSWITCH up to 40 A							X
terminals in attached terminal box (with cable gland)	X	X	X			X	X
terminals inside the unit (without cable-gland)				X	X		
flat terminals up to max. 35 A	X	X	X	X	X		
device terminals up to max. 60 A		X	X				
bolt terminals M6 up to max. 60 A		X	X	X	X		
bolt terminals M8 up to max. 115 A		X	X	X	X		
PA cage clamp terminals up to max. 30 A		X	X				

Electrical and mechanical data

Types FGFG, FGFK, FGFKQ, FGFL, FGFLQ, FGFT, FGFX	power in kW at 40°C and 100% DCF	Production Range Ω-value		max. number of laminas LBS6 type	dimension in mm				max. weight in kg
		from	up to		A	B	C2 ②	C3 ③	
FGF.. 61008..	4,0	0,3	160	8	270	295	330	355	7,5
FGF.. 61010..	5,0	0,3	128	10	270	295	330	355	8,5
FGF.. 61112..	6,0	0,4	107	12	270	295	330	355	9,5
FGF.. 61114..	7,0	0,5	92	14	370	395	430	455	12
FGF.. 61216..	8,0	0,6	80	16	370	395	430	455	13
FGF.. 61218..	9,0	0,6	72	18	570	595	630	655	18
FGF.. 61221..	10,5	0,8	61	21	570	595	630	655	20
FGF.. 61224..	12,0	0,9	54	24	570	595	630	655	22
FGF.. 61327..	13,5	1,0	48	27	770	795	830	855	29
FGF.. 61330..	15,0	1,1	43	30	770	795	830	855	31
FGF.. 61334..	17,0	1,2	38	34	770	795	830	855	33
FGF.. 61438..	19,0	1,4	34	38	970	995	1030	1055	40
FGF.. 61442..	21,0	1,5	31	42	970	995	1030	1055	42
FGF.. 61444..	22,0	1,6	29	44	970	995	1030	1055	44

This table represents only a selection of our program. All number of laminas between 2 pcs. (1,0 kW) and 44 pcs. (22 kW) corresponding to our types are available.

Type code and selection of units see on this pages T527E and T528E.

e.g.: 2 device terminals + temperature switch (2 terminals) => FGFKQ 61...04

② dim. C2 is only valid for type FGFG (dimension sheet 15M0057)

③ dim. C3 is only valid for types FGFK, FGFX and FGFT (dim.sheet 15M0768)

for type FGFL dim. „B“ is valid, as design without term.box (dim.sheet 15M0767)

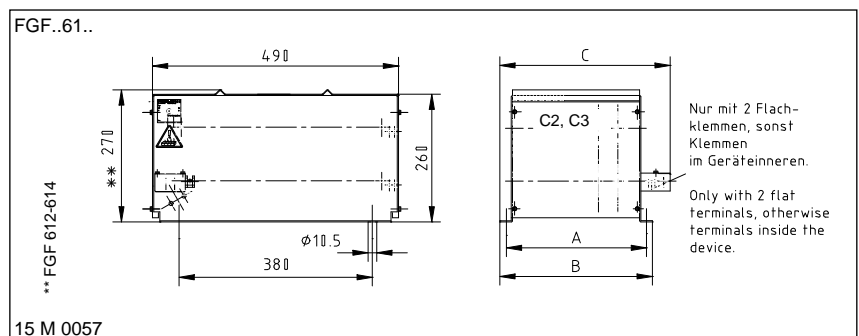



Type series FSL 16.. up to FSL 20..
Type series FAL 16.. up to FAL 20..

0,25 – 4,5 kW with up to 12 terminals



FSL 191206

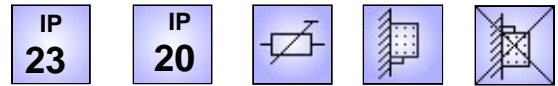

FSL... Wirewound lamina type fixed resistor, degree of protection IP 23 with weatherproof roof
FAL... Wirewound lamina type fixed resistor, degree of protection IP 20 without weatherproof roof

In zinc plated steel sheet enclosure with up to 12 terminals and several holes for cable glands, that are closed by rubber sockets.

Technologies

- continuous dissipation up to 4,5 kW
- wall mounting only (laying mounting not allowable!)
- adjustable clips possible
- up to 12 terminals possible
- temperature switch is not provided

The resistance value can be changed by means of adjustable clips. The number of available adjustable clips depends on type and wiring.

Intermediate values of power can be achieved by variation of the number of laminas. (For three-phase version a multiple of 3)

The number of terminals is determined by position 5 and 6 of the type. (see dimensioning example)

You will find further details for short term dissipation in chapter Technical Details, pages T513 - T517.

Application

- Braking resistor for medium power ratings and medium ohmic values in degree of protection IP 23 and IP 20
- starting and regulating resistor for three-phase slip-ring rotor motors
- three-phase load resistor with partial resistances

Special design

- version of low induction and of low noise (support straps made of aluminium or stainless steel)
- version with degree of protection IP 00, type series FKL 16.. up to FKL 20.. . The dimensions are identical with FAL ..
- terminals BK M6 (max.6 pcs.) and/or. M8 (max. 3 pcs.)

Electrical and mechanical data

Type FSL... FAL...	power in kW at 40°C and 100%DCF	production range Ω-value (total resistance)		number of lamina and size	drill holes for cable entry point M	maximum # of terminals up to 35A
		from	up to			
F. L 1602..	0,250	0,23	40	2 L2	1PG9 + 1PG16	7
F. L 1603..	0,375	0,35	60	3 L2		7
F. L 1704..	0,50	0,46	80	4 L2	1PG9 + 1PG16	7
F. L 1706..	0,75	0,69	120	6 L2		7
F. L 1805..	1,00	0,90	150	5 L3	3PG13,5 + 1PG16	10
F. L 1806..	1,20	1,10	180	6 L3		10
F. L 1906..	1,50	1,50	250	6 L4	1PG13,5 + 1PG16 + 3PG21	12
F. L 1909..	2,25	2,20	380	9 L4		12
F. L 1912..	3,00	3,00	510	12 L4		12
F. L 2015..	3,75	3,70	640	15 L4	1PG13,5 + 1PG16 + 3PG21	12
F. L 2018..	4,50	4,40	770	18 L4		12

Type FSL... FAL...	dimension in mm								max. weight in kg
	A	B	∅ C	D	E	F	G only FSL	L	
F. L 16..	155	210	5,8	190	235	130	270	12,5	3,0
F. L 17..	155	210	5,8	190	235	180	270	12,5	5,0
F. L 18..	165	270	5,8	230	295	182	335	12,5	7,0
F. L 19..	220	370	8,5	290	410	200	480	18	15
F. L 20..	220	370	8,5	290	410	335	480	18	25

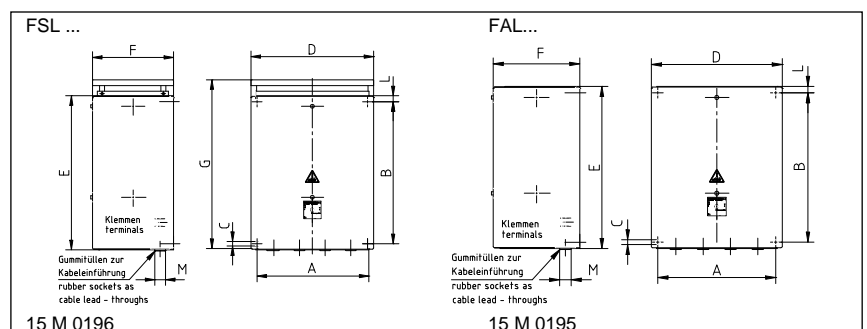

Example of dimensioning and selection of a specific unit:

Three-phase load resistor 3 x 1,5 kW = 4,5 kW; for 3 x 230/400 V; 50 Hz; 3 x 6,6 A, 3 x 35 Ω; wired on 3 flat terminals 35 A. Star point in the resistor.
Selected: FSL 201803 – 3 x 35 with continuous dissipation 4,5 kW

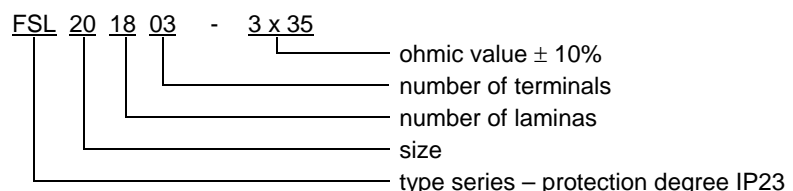



Type series FSL 70.. up to FSL 75..
Type series FAL 70.. up to FAL 75..

2,5 - 30 kW, with up to 30 terminals



FSL 732421



FSL... Wirewound lamina type fixed resistor, degree of protection IP 23 with weatherproof roof
FAL... Wirewound lamina type fixed resistor, degree of protection IP 20 without weatherproof roof

in zinc plated steel sheet enclosure with up to 30 terminals and cable entry strip. The terminals are accessible after the removal of the cover.

Technologies

- continuous dissipation up to 30 kW
- for floor mounting
- max. 30 flat terminals up to 35 A
- max. 19 bolt terminals up to 115 A
- adjustable clips possible
- temperature switch is not provided

Intermediate values of power can be achieved by variation of the number of laminas. (For three-phase version a multiple of 3)

Various application are possible because of the high number of available terminals. The number of terminals is determined by position 5 and 6 of the type.
(see dimensioning example)

Optionally it is also possible to make the resistance value adjustable by adjustable clips. The number of available adjustable clips depends on type and wiring

You will find further details for short term dissipation in chapter Technical Details, pages T513E-T517E.

Application

- Braking resistor for medium power ratings and medium ohmic values in degree of protection IP 23 and IP 20
- starting and regulating resistor for three-phase slip-ring rotor motors
- three-phase load resistor with partial resistor

Special design

- version of low induction and of low noise (support straps made of aluminium or stainless steel)
- version with higher number of terminals, higher rating or different degree of protection on request
- console for wall mounting is available

Electrical and mechanical data

Type	power in kW at 40°C and 100% DCF	production range Ω-value (total resistance)		max. number of laminas and size	maximum # of terminals in dependency of the size		
		from	up to		FK 35 A	BK M6 60 A	BK M8 115 A
F. L 7015..	3,75	0,3	150	15 L4	12	9	7
F. L 7124..	6,0	0,5	100	24 L4	18	14	11
F. L 7236..	9,0	0,7	64	36 L4	24	19	16
F. L 7330..	13	1,0	42	30 L7	21	15	14
F. L 7445..	19	1,5	30	45 L7	30	21	19
F. L 7569..	30	2,3	19	69 L7	30	21	19

Type	dimension in mm							max. weight in kg
	A	B	C	∅ D	E	F	G only IP23	
F. L 7015..	500	300	250	8,5	300	270	560	25
F. L 7124..	500	300	250	8,5	430	400	560	30
F. L 7236..	500	300	250	8,5	600	570	560	40
F. L 7330..	800	390	330	10,5	505	465	870	60
F. L 7445..	800	390	330	10,5	685	645	870	85
F. L 7569..	800	550	490	10,5	685	645	870	130

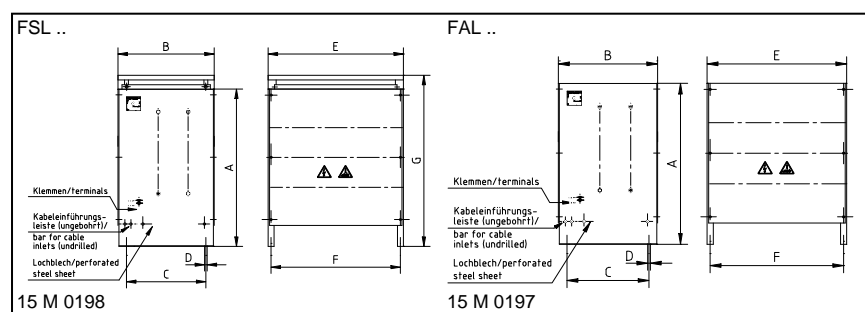

Example of dimensioning and selection of a specific unit:

Three-phase load resistor 3 x 2,5 kW = 7,5 kW; for 3 x 230/400 V; 50 Hz; 3 x 11 A, 3 x 21 Ω; wired on 3 flat terminals 35 A. Star point in the resistor.
Selected: FSL 723603 – 3 x 21 with continuous dissipation 8,6 kW

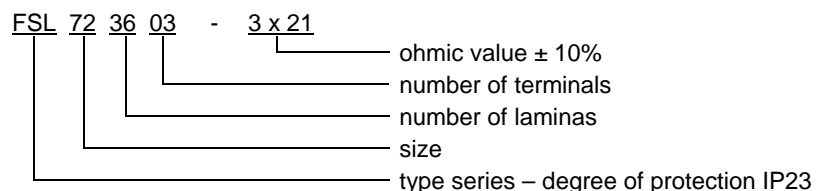



Type series FAV 6../ FSV 6..

75 – 250 kW with several terminals



FSV 6867637

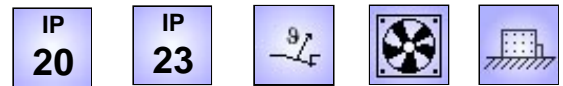

- FAV... lamina type fixed resistor in protection degree IP 20, without weatherproof roof, air outlet on top
- FSV... lamina type fixed resistor in protection degree IP 23, with weatherproof roof, for outdoor location, air outlet at the side via air deflectors in the upper area

In completely closed zinc sheet enclosure with protective grid at the bottom and powered ventilation by an integrated ventilator. With air flow monitoring by wind indicator relay. Ceramic insulated flat or bolt terminals of 35A up to 400A in variable combinations available.

Technologies

- constant ohmic value over a large temperature range
- power ventilated by integrated 230/400 V; 50 Hz axial flow fan
- for floor-level location
- continuous dissipation up to 250 kW
- paralleling of 2 or more units for even higher powers
- for outdoor location (FSV..)

The necessary terminals are mounted on a terminal strip in the lower part of the device and are accessible after demounting a cover,

By the use of lamina-elements with a typical power of 950 W or 1380 W per element with forced-ventilation, we cover a power range of up to 250 kW per unit. Constant ohmic value over a large temperature range of +/- 1% with maximum load. Higher power ratings can be achieved by parallel connection of several devices.

Application

An important application is the use as a temperature independent load resistor, which means a constant ohmic value under maximum load for exact test and laboratory equipment. Protection degree IP 20 is sufficient for installing in laboratory or factory rooms, IP 23 is necessary for outdoor location.

Special design

- with integrated switching devices in an attached switch cabinet to control the partial resistors
- with 2 temperature switches wired on terminals
- special voltages of fan
- mobile, for test area by rollers

Electrical and mechanical data

Type FAV 6.. FSV 6..	power in kW at 40°C and 100% DCF	maximum number of laminas	dimension in mm						max. weight in kg
			A	B	C	D	E	F	
F.V 68580..	75	80 L7	1200	1240	800	700	795	770	142
F.V 68680..	110	80 L10	1500	1540	800	700	795	770	185
F.V 68780..	170	180 L7	1435	1485	955	850	995	970	265
F.V 68880..	250	180 L10	1700	1750	955	850	995	970	370

This table represents only the maximum number of lamina-resistors for the specific size of unit and the corresponding maximum typical power. Many specifications depending on customer requirement are possible.

